

DESIGN • PRINT MANUFACTURE 2012

Display Solutions from Kerb to Counter... and Beyond





space³

signage graphics 3^d design

Hello..

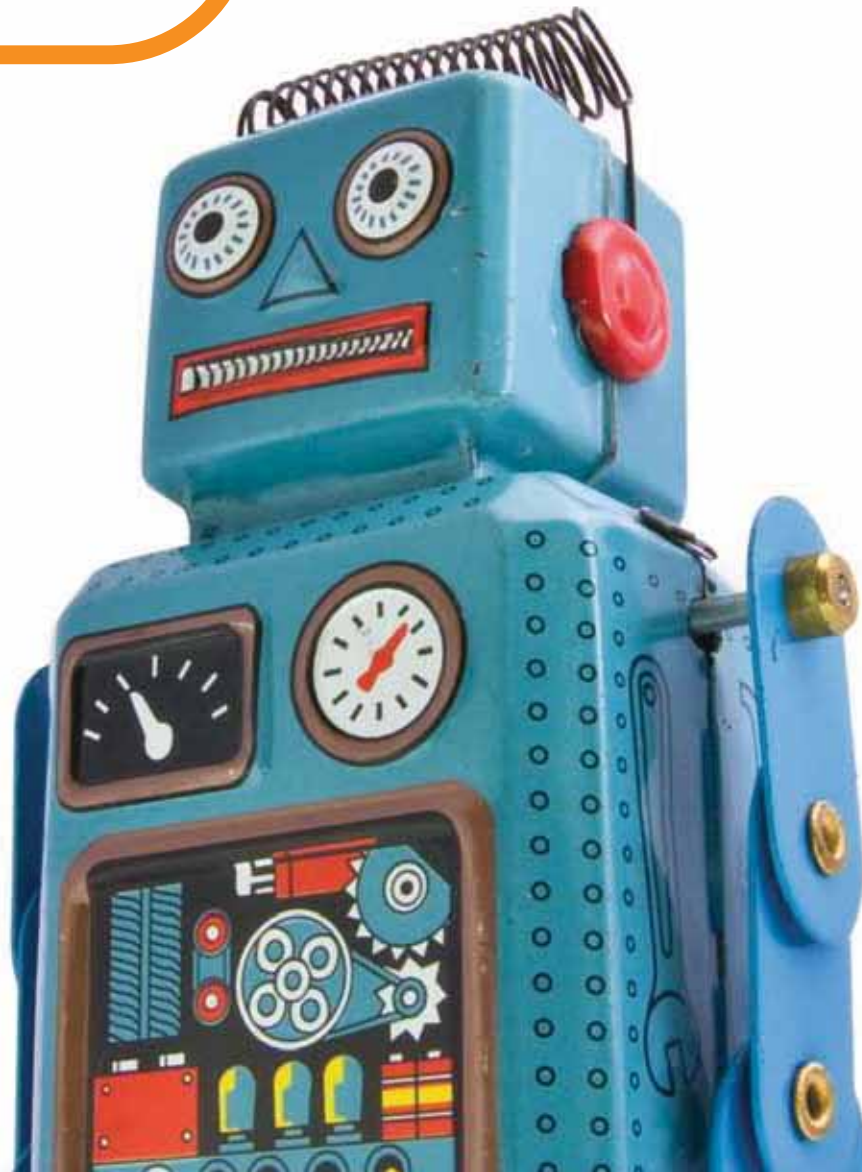



Standard Finish Snapframes | Page 23



Counterstand Snapframes | Page 29



Illuminated Menu Case | Page 39



GripChalkers | Page 44



Sentinel A0 Forecourt Sign | Pages 48-49



Sightmaster Pro Forecourt Sign | Page 50



Petite Promo Stand | Page 60



Edgelit XT LED Snapframe | Page 71



Brochure Island Stands | Pages 78-79



GripTalkers | Page 81



Portland Menustand | Page 83



Pavement Signs & A-Boards

Pages 6 – 21

Poster Frames, Holders & Displays

Pages 22 – 43



Chalkboards & Accessories

Pages 44 – 47

Forecourt (Large Format) Signs

Pages 48 – 53



Portable Exhibition Displays

Pages 54 – 61

Projecting Signs & Flags

Pages 62 – 69



Lightboxes & Illuminated Displays

Pages 70 – 75

Menu & Brochure Displays

Pages 76 – 83



Freestanding Modular Displays

Pages 84 – 93

Printed Displays
Pages 94 – 97



Product Display & Presentation
Pages 98 – 101

Café & Rope Barrier Systems
Pages 102 – 104



Accessories & Spares
Pages 105 – 106

Green Guide



Look out for **recyclable parts/materials** and **green symbols** throughout this brochure, which highlight the environmental benefits of our products.

Use of Recyclable Materials

The vast majority of our products are made with materials that can be recycled when the product reaches its 'end of life'.

Use of Recycled Materials

Some of our products are made using recycled materials. Examples include our pavement sign and forecourt sign bases.

Designed for Easy 'End of Life' Recycling

This means that a product can be quickly and easily dismantled at 'end of life', allowing the different component materials to be separated for recycling.

We take great care to minimise the impact of our business on the environment. This includes employing eco-design principles, reducing the use of road vehicles, improving the energy efficiency of appliances and installing motion-sensored lighting. All product packaging uses at least 80% recycled board material and is also considered for reduction of transport volume. We do not work with endangered wood species or with suppliers who are unable to provide evidence that the wood in their products is from sustainable sources. **Please contact us if you would like further information on our environmental policy.**

Other helpful symbols:

 **Assembly times**
Based on one person unless otherwise stated

 **No tools assembly**
Easy to assemble by hand

 **In stock**
Usually available next day (unless print required)

 **Made to order**
Longer lead times and minimum order quantities may apply. Please ask for details.

Swinger

The UK's No.1 Pavement Sign

Patent No. EP 0809227 UK Design Registration No. 2071096 EU Design Registration No. 001274229

Why is Swinger the UK's market-leading pavement sign?

- Beautifully designed and engineered
- Quick and easy 'no tools' assembly
- Soft round styling for high pedestrian safety
- Low centre of gravity for maximum stability
- Individually boxed and flat-packed with instructions
- Fully recyclable



Eco Swinger



Swinger 2000 (Poster Option)



Swinger 3000 (Panel Option)



Swinger 4000



D-Flex Panel Hangers

Patent No. GB 2437991

- Enable quick and easy 'no tools' panel fitting
- Absorb impact, preventing damage to the panel and therefore ensuring long-life



'No Tools' Assembly

Patent No. EP 0809227

- Simply push base onto frame

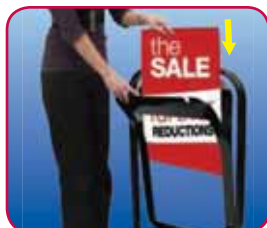

Top-Opening Poster Pockets

Patent No. GB 2464773 EU Design Registration No. 001274229

- Quick and easy poster change
- Virtually no risk of poster loss
- Self-closing magnetic seals
- Excellent weather resistance



Built-In Wheels

- Allow easy and safe movement
- Fitted on Swinger 3000 and 4000



Water-Fillable Bases

- Ensure optimum stability
- Fitted as standard on Swinger 3000 and 4000
- Also available on Swinger 2000 (minimum order quantity applies)

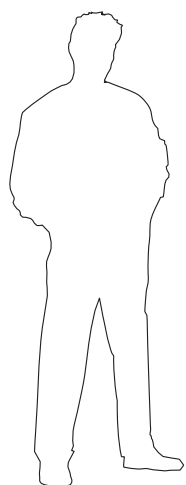

The Swinger Family



	Eco Swinger	Eco Swinger 2	Swinger 2000	Swinger 3000	Swinger 4000
Panel Option	✓	✓	✓	✓	✗
Poster Option	✗	✗	✓	✓	✓



With stock black frame



'D-Flex' panel hangers make panel fitting quick and easy



Quick and easy 'no tools' assembly



Also available with A3 poster pockets

Eco Swinger

- Gloss white aluminium panel (430 × 625mm) – ideal for screen/digitally printed graphics or vinyl application
- Stylish 32mm round steel tube frame – available in black or white from stock
- Frames also available in any RAL colour (minimum order quantity: 25)
- Patented 'D-Flex' panel hangers make panel fitting quick and easy
- Solid black recycled PVC base provides excellent stability
- Also available with top-opening poster pockets for A3 poster display – see page 20 for details



In stock



No tools assembly



1 minute to assemble



Recyclable
Aluminium panel, steel frame and recycled PVC base

Specification				
Display Area (mm)	O/A Dimensions (w × h × d mm)	Weight (kg)	Frame Colour	Order Code
430 × 625	534 × 811 × 490	10	White	SWIECOW
			Black	SWIECOB



With stock white frame



'D-Flex' panel hangers make panel fitting quick and easy



Designed with safe finger clearances for ease of movement

Eco Swinger 2

Like Eco Swinger, but with a taller frame and extended panel

- Gloss white aluminium panel (430 × 750mm) – ideal for screen/digitally printed graphics or vinyl application
- Stylish 32mm round steel tube frame – available in black or white from stock
- Frames also available in any RAL colour (minimum order quantity: 25)
- Patented 'D-Flex' panel hangers make panel fitting quick and easy
- Solid black recycled PVC base provides excellent stability



In stock



No tools assembly



1 minute to assemble



Recyclable
Aluminium panel, steel frame and recycled PVC base

Specification				
Display Area (mm)	O/A Dimensions (w × h × d mm)	Weight (kg)	Frame Colour	Order Code
430 × 750	534 × 936 × 490	11	White	EXTECOW
			Black	EXTECOB

Swinger 2000

Panel Option

- Gloss white **aluminium panel** (500 × 750mm) – ideal for screen/digitally printed graphics or vinyl application
- Stylish oval **steel tube frame** (50 × 25mm) – available in black or white from stock
- Frames also available in any RAL colour (minimum order quantity: 25)
- Patented 'D-Flex' panel hangers make panel fitting quick and easy
- Solid black **recycled PVC base** provides excellent stability
- Water-fillable **polyethylene bases** available in any RAL colour (minimum order quantity: 500)



In stock



No tools assembly



1 minute to assemble



Recyclable
Aluminium panel, steel frame and recycled PVC/polyethylene base



With stock white frame and recycled PVC base



Patented 'D-Flex' panel hangers



Quick and easy 'no tools' assembly

Specification

Display Area (mm)	O/A Dimensions (w × h × d mm)	Weight (kg)	Frame Colour	Order Code
500 × 750	600 × 940 × 520	15	White	SW750W
			Black	SW750B

Swinger 2000

Poster Option

- Double-sided A2 poster display
- Top-opening **polycarbonate poster pocket** with magnetic seals (see page 7 for details)
- Poster pockets available in black or white from stock and suitable for screen/digitally printed graphics or vinyl application
- Stylish oval **steel tube frame** (50 × 25mm) – available in black or white from stock or any RAL colour (minimum order quantity: 25)
- Patented 'D-Flex' panel hangers make panel fitting quick and easy
- Solid black **recycled PVC base** provides excellent stability
- Water-fillable **polyethylene bases** available in any RAL colour (minimum order quantity: 500)



In stock



No tools assembly



1 minute to assemble



Recyclable
Polycarbonate poster pocket, steel frame and recycled PVC/polyethylene base



With printed poster pocket, stock black frame and recycled PVC base



Patented 'D-Flex' panel hangers



Top-opening poster pockets

Specification

Poster Size	Display Area (mm)	O/A Dimensions (w × h × d mm)	Weight (kg)	Colour (Pocket/Frame)	Order Code
A2	400 × 575	600 × 940 × 520	15	White	SW2000WTOP
				Black	SW2000BTOP

Swinger 4000

- Double-sided A1 poster display
- Top-opening polycarbonate poster pocket with magnetic seals (see page 7 for details)
- Black poster pockets as standard, suitable for vinyl application. Available screen/digitally printed to order (minimum order quantity: 25).
- Stylish oval steel tube frame (50 x 25mm) – available in any RAL colour (minimum order quantity: 25)
- Patented 'D-Flex' panel hangers make panel fitting quick and easy
- Black water-fillable polyethylene base for optimum stability – also available in any RAL colour (minimum order quantity: 500)
- Built-in wheels for ease of movement



With printed poster pocket and stock black frame



In stock



No tools assembly



1 minute to assemble



Recyclable
Polycarbonate poster pocket,
steel frame and polyethylene base

Specification					
Poster Size	Display Area (mm)	O/A Dimensions (w x h x d mm)	Weight (kg) Empty/Full	Colour (Pocket/Frame)	Order Code
A1	574 x 822	774 x 1191 x 600	14/32	Black	SW4000BBTOP

Base volume: 18 litres.



Top-opening poster pockets



Water-fillable bases for optimum stability

Tactical Header for Swingers

- Simply clips on top of Swinger 2000, 3000 and 4000 frames
- Ideal for short-term promotions – additional advertising site for minimal cost
- 1mm rigid gloss white PVC panel for vinyl or screen/digitally printed graphics
- Supplied complete with clips



Specification			
Type	Dimensions (mm)	Stock Status	Order Code
Swinger 2000	542 x 200	In stock	TH2000
Swinger 3000	629 x 231	Made to order	–
Swinger 4000	716 x 200	Made to order	–



In stock
For Swinger 2000



Recyclable
PVC panel



Custom-shaped headers also available



Made to order
Minimum order quantity: 25



Ecoflex

The 'eco-nomical' and 'eco-friendly' high performance sign, ideal for pavement, roadside and forecourt promotions



Bases available with embossed logos (minimum order quantities apply)



Single nylon fixing secures panel to base (view from underneath)



Chosen by leading brands and retailers



Tested in winds over 70 mph



In stock



No tools assembly



2 minutes to assemble



Recyclable
Aluminium panel and recycled PVC base

Specification				
Panel Size (mm)	Display Area (mm)	O/A Dimensions (w x h x d mm)	Weight (kg)	Order Code
460 x 850	460 x 783	523 x 870 x 490	9	ECOFLEX

Create truly unique and eye-catching designs with shaped panels, brought to life with our vibrant screen and digital print...



Maximum display area for shaped panels (for exterior use):

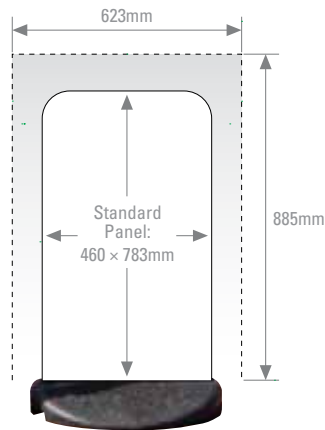

Looking for something bigger?
See the **Ecoflex Totem** on page 20.



Made to order
Minimum order quantity: 25

Ecoflex HPL

All the features of Ecoflex but with a chalkboard panel

- 3mm double-sided 'High Pressure Laminate' panel
- Suitable for soft chalk and liquid chalk pens
- Ideal for screen/digitally printed graphics or vinyl application

For more information on HPL and chalk pens, see page 47.



In stock



No tools assembly



1 minute to assemble



Recyclable
Recycled PVC base

Specification				
Panel Size (mm)	Display Area (mm)	O/A Dimensions (w x h x d mm)	Weight (kg)	Order Code
460 x 850	460 x 783	523 x 870 x 490	11	ECOFLEXHPL





Budget A-Board

- Double-sided display for self-adhesive vinyl graphics
- Suitable for sheltered locations only
- Chalkboard version suitable for liquid chalk pens (see page 47 for details)



In stock



No assembly required



Recyclable

High impact polystyrene (HIPS) panels

Specification				
Display Area (mm)	O/A Dimensions (w x h x d mm)	Weight (kg)	Option	Order Code
480 x 815	500 x 880 x 640	4.3	White	ABPSP
			Chalkboard	ABPSCB



A-Board

- Fixing free aluminium panel surface – ideal for screen/digitally printed graphics or vinyl application
- Double-sided 500 x 700mm display area
- Steel tube frame (32mm diameter), powder coated white. Also available in any RAL colour (minimum order quantity: 25)
- Supplied pre-assembled and ready for use



In stock



No assembly required



Recyclable

Steel frame and aluminium panels



Chrome oval chain maintains optimum leg angle

Specification				
Display Area (mm)	O/A Dimensions (w x h x d mm)	Weight (kg)	Colour	Order Code
500 x 700	564 x 860 x 700	9	White	AB100W

A-Master A-Boards



With silver anodised frame



With black powder coated frame

- Double-sided poster display in a wide range of sizes
- Front-opening aluminium snapframes with round corners for safety (32mm profile)
- Anti-glare poster covers with high UV resilience
- Galvanised steel back panels and hinged locking arms for optimum weight and stability
- Available in silver anodised or black powder coated finishes from stock
- Custom sizes and colours available made to order (minimum order quantity: 50)
- 'Fold-flat' design – easy to move and store

In stock
Certain sizes made to order (see below)

No assembly required

Recyclable
Aluminium frames, aluminium legs, poster covers and galvanised steel back panels



Front-opening snapframes for quick and easy poster change



Locking side arms ensure stability

Specification							
Poster Size	Display Area (mm)	O/A Dimensions (w × h × d mm)	Leg Length* (mm)	Weight (kg)	Stock Status	Finish	Order Code
A2	400 × 574	463 × 910 × 700	950	6.2	In stock	Silver	ABA2GR(W)
						Black	ABA2BR(W)
A1	574 × 821	637 × 1100 × 800	1150	10.2	In stock	Silver	ABA1GR(W)
						Black	ABA1BR(W)
A0	821 × 1169	884 × 1400 × 910	1450	18.6	In stock	Silver	ABA0GR(M)
20" × 30"	488 × 742	551 × 910 × 700	950	9	In stock	Silver	AB23GR(W)
						Black	AB23BR(W)
30" × 40"	742 × 996	805 × 1200 × 850	1250	13.8	Made to order		UAB3200N34
500 × 700mm	480 × 680	543 × 910 × 700	950	8.4		Silver	UAB3200NB2
700 × 1000mm	680 × 980	743 × 1200 × 850	1250	13.4			UAB3200NB1

*Leg profile: 30 × 15mm.



A-Master Plus

- Double-sided A1 poster display
- Snapframe header for 594 × 176mm insert (white back panel included, suitable for vinyl application)
- Front-opening aluminium snapframes with round corners for safety (32mm profile, silver anodised finish)
- Anti-glare PVC poster covers with high UV resilience
- Galvanised steel back panels and hinged locking arms for optimum weight and stability
- Custom sizes and colours available made to order (minimum order quantity: 50)
- 'Fold-flat' design – easy to move and store



In stock



No assembly required



Recyclable

Aluminium snapframes, aluminium legs, PVC poster covers and galvanised steel back panels

Specification				
Poster Size	Display Area (w × h mm)	Dimensions (mm)	Weight (kg)	Order Code
A1	Poster: 574 × 821 Header: 574 × 156	O/A: 640 × 1112 × 807 Leg: 30 × 1173 × 15 Poster: 594 × 841 Header: 594 × 176	10.6	ABA1PLUS



Informer

- Double-sided 20" × 30" poster display
- Anti-glare PET poster covers with magnetic seals – excellent poster security and weather resistance (includes colour matched printed border)
- Simply push poster cover out of frame via hidden release hole in back panel
- White polyester powder coated steel frame as standard. Also available in any RAL colour (minimum order quantity: 50)
- Folds flat for efficient storage



In stock



No assembly required



Recyclable

Steel frame, steel back panels and PET poster covers

Specification				
Poster Size	Display Area (mm)	O/A Dimensions (w × h × d mm)	Weight (kg)	Order Code
20" × 30"	505 × 759	570 × 890 × 550	12	IN230W(W)



Magnetic sealed poster covers



Hidden poster cover release hole in back panel

Booster

Attractive poster A-board with semi-circular header

- Double-sided poster display with additional header area – ideal for vinyl application
- Anti-glare **PET poster covers** with magnetic seals – excellent poster security and weather resistance (includes colour matched printed border)
- Simply push poster cover out of frame via hidden release hole in back panel
- **Steel tube frame** (25mm diameter) and **steel back panels** – available in a choice of stock colours
- Also available in any RAL colour made to order (minimum order quantity: 50)
- Locking side arms ensure stability



In stock



No assembly required



Recyclable

Steel frame, steel back panels and PET poster covers



Booster with black frame and printed header



Booster with silver/grey frame and printed header



Magnetic poster covers – simply push out via hidden release hole



Locking side arms ensure stability



Turn your Booster into a chalk A-board with our Chalk Insert Panels

Chalk Insert Panels	
Size	Order Code
A2	INFA2CCB
20" x 30"	INF2030CCB
A1	INFA1CCB

Specification					
Poster Size	Display Area (mm)	O/A Dimensions (w x h x d mm)	Weight (kg)	Colour	Order Code
A2	420 x 594	500 x 1065 x 700	12.7	White	BRA2W(M)
				Black	BRA2B(M)
20" x 30"	508 x 762	588 x 1220 x 850	15.3	White	BR230W(M)
				Black	BR230BL(M)
				Silver/Grey	BR230S(M)
A1	594 x 841	674 x 1410 x 900	18.5	White	BRA1W(M)
				Black	BRA1BL(M)

Premier Chalk A-Boards

Available in 2 sizes with traditional wood or stylish steel frames

- Reversible HPL panels – 4 messages in 1
- Stylish locking side arms ensure stability
- Supplied fully assembled and individually boxed with instructions
- Suitable for soft chalk and liquid chalk pens (see page 47 for details)



In stock



No assembly required

For further information about the HPL chalkboard panels used in these A-boards, see page 47.



Heavy duty galvanised steel hinges (wood)



Reversible HPL panels on all models



Stylish locking side arms on all models



Indestructible rubber hinges (steel)

Steel Frames

- Unique indestructible rubber hinges allow feet to self-level on uneven surfaces
- 50 × 50mm black powder coated frames, also available in any RAL colour (minimum order quantity: 25)

Specification					
Size	Display Area (mm)	O/A Dimensions (w × h × d mm)	Weight (kg)	Colour	Order Code
Small (3mm HPL)	542 × 813	645 × 845 × 590	13	Black	PREMASMM
Large (4mm HPL)	709 × 1049	810 × 1190 × 690	19	Black	PREMALGM

Wood Frames

- Heavy duty galvanised steel hinges
- 45 × 45mm softwood frames from renewable sources
- Dark oak finish with matt varnish protection

Specification					
Size	Display Area (mm)	O/A Dimensions (w × h × d mm)	Weight (kg)	Finish	Order Code
Small (3mm HPL)	550 × 805	640 × 905 × 670	13	Dark Oak	PREMASMW
Large (4mm HPL)	717 × 1041	810 × 1145 × 770	19	Dark Oak	PREMALGW



Printed/shaped panels and coloured steel frames available

(Minimum order quantity for coloured frames: 25)

HPL A-Board

- 6mm solid 'High Pressure Laminate' panels
- Frameless design keeps costs to a minimum
- Indestructible rubber hinges
- Individually carton packed
- Suitable for use with soft chalk and liquid chalk pens

For more information on HPL and chalk pens, see page 47.



Made to order
Minimum order quantity: 10



No assembly required



Specification		
Display Area (mm)	O/A Dimensions (w x h x d mm)	Order Code
560 x 800	563 x 833 x 407	ABHPL5680

Waterbase Pyramid

- Durable **polyethylene** construction
- Water-fillable for optimum stability (5 litre capacity)
- Graphic area: 330 x 385mm with 25mm corner radius (sticker inlay required)
- Supplied flat packed in 3 parts



In stock



No tools assembly



3 minutes to assemble and fill



Recyclable
Polyethylene construction



Parts simply push together



Water-fillable base



Specification			
Display Area (mm)	O/A Dimensions (w x h x d mm)	Weight (kg) Empty/Full	Order Code
330 x 385	370 x 1125 x 370	3.6/5.5	WBPSGREY

Also available in custom colours (minimum order quantity: 500).

Waterbase A-Board

- Durable **polyethylene** construction
- Water-fillable for optimum stability (5 litre capacity)
- Graphic area: 325 x 570mm (sticker inlay required)
- Folds flat for efficient storage



In stock



No tools assembly



2 minutes to assemble and fill



Recyclable
Polyethylene construction



Specification			
Display Area (mm)	O/A Dimensions (w x h x d mm)	Weight (kg) Empty/Full	Order Code
325 x 570	410 x 754 x 470	3.6/8	WBABGREY

Also available in custom colours (minimum order quantity: 500).

Custom Pavement Signs



All made to order

Available re-branded / customised to order



Top-opening poster pockets



Quick and easy 'no tools' assembly

Eco Swinger Poster Option

Minimum order quantity: 25

All the features of our standard Eco Swinger, now with top-opening poster pockets for double-sided A3 poster display. Custom colour frames and printed poster pockets are available for added impact and brand presence. Quick and easy 'no tools' assembly and our patented 'D-Flex' panel hangers complete this small but perfectly formed poster sign.

For further information about our top-opening poster pockets, see page 7.



Swinger Totem

Minimum order quantity: 50

Based on our standard Swinger, this sign incorporates a water-fillable base, extended steel tube frame and 5 interchangeable swinging aluminium panels.

This type of sign could be easily adapted to suit a wide variety of brands and retailers.

Call us to discuss your ideas.



British POP Award Winner Silver

Sentinel Totem

Minimum order quantity: 25



Alternative design featuring our water-fillable Sentinel base (see page 48) with an eye-catching permanent graphic panel and menu sticker set.



Extended Swinger

Minimum order quantity: 50

With our solid recycled PVC base and an extended steel tube frame, the enlarged poster panel offers greater space for permanent branding.

This type of sign would suit a wide variety of brands and retailers looking for a high impact poster sign.



Ecoflex Totem

Minimum order quantity: 10

The specially modified recycled PVC base can hold 3mm aluminium composite panels up to 1.7m tall, opening up new opportunities for 'larger than life' displays from our market-leading sign.

Recommended for internal and sheltered outdoor use only

Bobby

Minimum order quantity (guide): 1000

Patent No. GB 2320358 Design Registration No. 2061766 & 2061767

'Bobby' is a self-righting pavement sign developed in 2003 as part of a major project for The National Lottery and one of the largest single POP roll-outs in Europe.

Bobby's low centre of gravity and counter weight ensure that it always bounces back.

Intended to reflect the fun and excitement of the Lottery, Bobby is also high impact and hassle free, with no maintenance needed and no replacement parts.



The pavement sign that wobbles but won't fall down!



**British POP
Award Winner**
Gold Award for
Innovation

Eco-Design Litter Bin

Minimum order quantity: 500

The 'Eco-Design Litter Bin' creates a 'front of store' brand presence at the point-of-purchase with real benefit to the retailer, the consumer and the environment.

Eco-design principles include:

- Use of low impact materials
- Use of recycled materials
- Use of recyclable materials
- Reduction of weight
- Reduction in transport volume

The bin components nest within each other to minimise volume and therefore packaging, shipping, storage and onward distribution costs.



**British POP
Award Winner**
Gold Award for
Innovation



All components 'nest' within each other, allowing 4 x more units per pallet vs a conventional bin



Uses a standard bin liner



Slide over, tamper resistant lid



Easily carried using side carry handles

Snapframes



All our snapframes feature:

- Quick and easy poster change
- 'Security by intelligence' – when closed, all fixings and opening method are hidden from view
- Silver anodised finish as standard (unless otherwise stated)
- Anti-glare poster cover sheets
- Pre-drilled and individually boxed with screws and wall plugs
- White or grey plastic back panels depending on size/style
- Suitable for indoor or outdoor use

For added security, see our **Security** and **Lockable** Snapframes on page 28.



Recyclable

Aluminium frames, fluted polypropylene back panels and PVC/PET poster cover sheets. Mechanical fixings used throughout for easy 'end of life' recycling.



Front-opening snapframes for quick and easy poster change

Bespoke Snapframe Service

- Almost any size
- Any RAL colour
- No minimum order quantities!
- Wide range of profiles
Standard: 15, 25, 37 and 38mm
Security: 25mm
- Wood grain finish available on 25 and 37mm profiles

See our range of illuminated snapframes on pages 70-73

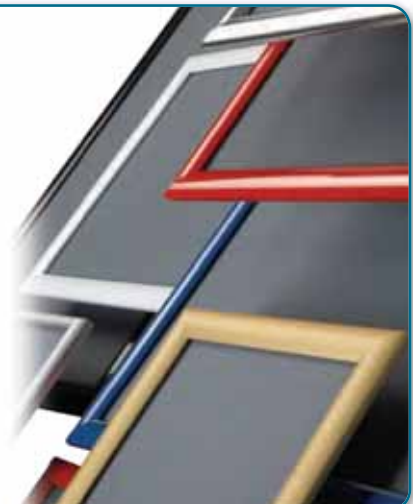

Quick Reference Guide

STANDARD Snapframes			Poster Size												
Profile (mm)	Corners	Standard Finish	A6	A5	A4	A3	A2	A1	A0	20" × 30"	30" × 40"	40" × 60"	500 × 700mm	700 × 1000mm	1000 × 1400mm
14	Mitred (soft)	Silver	TO	TO	X	X	X	X	X	X	X	X	X	X	X
15	Mitred	Silver	TO	✓	✓	✓	TO	TO	X	TO	X	X	TO	X	X
		Black	TO	✓	TO	TO	TO	TO	X	TO	X	X	TO	X	X
20	Mitred	Silver	TO	TO	TO	TO	TO	TO	TO	TO	TO	X	TO	TO	X
25	Mitred	Silver	X	TO	✓	✓	✓	✓	TO	✓	TO	TO	TO	TO	X
		Black	X	TO	✓	✓	✓	✓	TO	TO	TO	TO	TO	TO	TO
	Round	Silver	X	TO	✓	✓	✓	TO	TO	TO	TO	TO	TO	TO	X
26	Mitred or Round	Silver	X	X	TO	TO	TO	TO	TO	TO	TO	X	TO	TO	X
30	Round	Silver	X	X	TO	TO	TO	✓	TO	✓	TO	TO	TO	TO	TO
32	Mitred or Round	Silver	X	X	X	TO	TO	TO	TO	TO	TO	TO	TO	TO	TO
37	Mitred	Wood Grain	X	X	X	TO	TO	TO	TO	TO	TO	TO	TO	TO	TO
38	Mitred	Silver	X	X	X	TO	TO	TO	✓	TO	✓	✓	TO	TO	TO
45	Mitred	Silver	X	X	X	TO	TO	TO	TO	TO	TO	TO	TO	TO	TO
46	Mitred or Round	Silver	X	X	X	TO	TO	TO	TO	TO	TO	TO	TO	TO	TO

SECURITY Snapframes			Poster Size												
Profile (mm)	Corners	Standard Finish	A6	A5	A4	A3	A2	A1	A0	20" × 30"	30" × 40"	40" × 60"	500 × 700mm	700 × 1000mm	1000 × 1400mm
25	Mitred	Silver	X	X	✓	✓	✓	✓	TO	✓	TO	TO	TO	TO	X
42			X	X	X	TO	TO	TO	✓	TO	✓	✓	TO	TO	TO

LOCKABLE Snapframes			Poster Size												
Profile (mm)	Corners	Standard Finish	A6	A5	A4	A3	A2	A1	A0	20" × 30"	30" × 40"	40" × 60"	500 × 700mm	700 × 1000mm	1000 × 1400mm
32	Mitred	Silver	X	X	TO	✓	✓	✓	TO	TO	TO	TO	TO	TO	TO

✓ = In stock and available next day X = We don't stock or wouldn't usually recommend this size/profile combination, but could be made to order if required (minimum order quantities apply)
 TO = Available made to order

Standard Snapframe Finishes

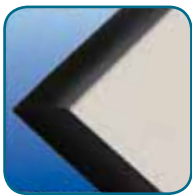

Black

In stock

A5*, A4, A3, A2, A1

Made to order

A0, 20" × 30",
30" × 40", 40" × 60",
500 × 700mm, 700 × 1000mm,
1000 × 1400mm

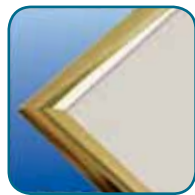

Gold

Made to order

A4, A3, A2, A1, A0,
20" × 30", 30" × 40", 40" × 60",
500 × 700mm, 700 × 1000mm,
1000 × 1400mm



Wood

Made to order

A4, A3, A2, A1, A0,
20" × 30", 30" × 40", 40" × 60",
500 × 700mm, 700 × 1000mm,
1000 × 1400mm

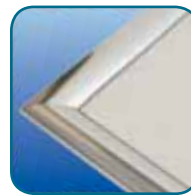

Chrome

Made to order

A4, A3, A2, A1, A0,
20" × 30", 30" × 40", 40" × 60",
500 × 700mm, 700 × 1000mm,
1000 × 1400mm

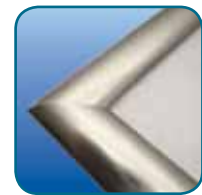

Stainless Steel

Made to order

A4, A3, A2, A1, A0,
20" × 30", 30" × 40", 40" × 60",
500 × 700mm, 700 × 1000mm,
1000 × 1400mm

*Uses our 15mm profile with mitred corners. All other sizes use our 25mm profile with mitred corners.

Standard Snapframes

Wonderfully quick and easy to use, these front-opening snapframes are operated by hand

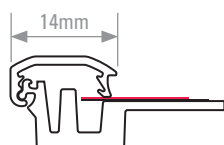

14mm Profile with Soft Mitred Corners

Poster Size	Display Area (mm)	O/A Dimensions (mm)	Weight (kg)	Stock Status	Order Code
A6	95 × 138	126 × 169	0.14	 Made to order	UCP145N0A6
A5	138 × 200	169 × 231	0.25		UCP145N0A5

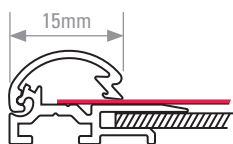

15mm Profile with Mitred Corners

Poster Size	Display Area (mm)	O/A Dimensions (mm)	Weight (kg)	Stock Status	Finish	Order Code
A6	85 × 128	115 × 158	–	Made to order	Silver	UCN155N0A6
A5	128 × 190	158 × 220	0.4	In stock	Silver	SNA515SA(W)
					Black	SNA515BLK(W)
A4	190 × 277	220 × 307	0.5	In stock	Silver	SNA415SA(W)
A3	277 × 400	307 × 430	0.7	In stock	Silver	SNA315SA(W)
A2	400 × 574	430 × 604	1.1	Made to order	Silver	UCN155N0A2
A1	574 × 821	604 × 851	2.1	Made to order	Silver	UCN155N0A1
20" × 30"	488 × 742	518 × 772	1.9	Made to order	Silver	UCN155N023
500 × 700mm	480 × 680	510 × 710	1.8	Made to order	Silver	UCN155N0B2

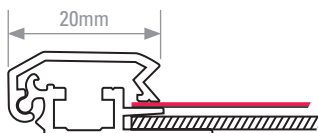

20mm Profile with Mitred Corners

Poster Size	Display Area (mm)	O/A Dimensions (mm)	Stock Status
A6	97 × 140	135 × 178	 Made to order
A5	140 × 202	178 × 240	
A4	202 × 289	240 × 327	
A3	289 × 412	327 × 450	
A2	412 × 586	450 × 624	
A1	586 × 833	624 × 871	
A0	833 × 1181	871 × 1219	
20" × 30"	500 × 754	538 × 792	
30" × 40"	754 × 1008	792 × 1046	
500 × 700mm	492 × 692	530 × 730	
700 × 1000mm	692 × 992	730 × 1030	

25mm Profile with Mitred Corners						
Poster Size	Display Area (mm)	O/A Dimensions (mm)	Weight (kg)	Stock Status	Finish	Order Code
A5	133 × 195	184 × 246	–	Made to order	Silver	UCN255N0A5
A4	195 × 282	246 × 333	0.5	In stock	Silver	SNA425SA(W)
					Black	SNA425BLK(W)
A3	282 × 405	333 × 456	0.8	In stock	Silver	SNA325SA(W)
					Black	SNA325BLK(W)
A2	405 × 579	456 × 630	1.3	In stock	Silver	SNA225SA(W)
					Black	SNA225BLK(W)
A1	579 × 826	630 × 877	2.3	In stock	Silver	SNA125SA(W)
					Black	SNA125BLK(W)
A0	826 × 1174	877 × 1225	4	Made to order	Silver	UCN255N0A0
20" × 30"	493 × 747	544 × 798	1.7	In stock	Silver	SN2325SA(W)
30" × 40"	747 × 1001	798 × 1052	3.4	Made to order	Silver	UCN255N034
40" × 60"	1001 × 1509	1052 × 1560	6	Made to order	Silver	UCN255N046
500 × 700mm	485 × 685	536 × 736	1.6	Made to order	Silver	UCN255N0B2
700 × 1000mm	685 × 985	736 × 1036	3	Made to order	Silver	UCN255N0B1

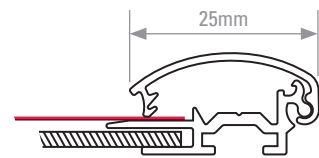

Other standard finishes available made to order. See page 23 for details.

25mm Profile with Round Corners					
Poster Size	Display Area (mm)	O/A Dimensions (mm)	Weight (kg)	Stock Status	Order Code
A5	133 × 195	184 × 246	–	Made to order	UCN250N0A5
A4	195 × 282	246 × 333	0.5	In stock	SNRA425SA(W)
A3	282 × 405	333 × 456	0.8	In stock	SNRA325SA(W)
A2	405 × 579	456 × 630	1.3	In stock	SNRA225SA(W)
A1	579 × 826	630 × 877	2.3	Made to order	UCN250N0A1
A0	826 × 1174	877 × 1225	4	Made to order	UCN250N0A0
20" × 30"	493 × 747	544 × 798	1.7	Made to order	UCN250N023
30" × 40"	747 × 1001	798 × 1052	3.4	Made to order	UCN250N034
40" × 60"	1001 × 1509	1052 × 1560	6	Made to order	UCN250N046
500 × 700mm	485 × 685	536 × 736	1.6	Made to order	UCN250N0B2
700 × 1000mm	685 × 985	736 × 1036	3	Made to order	UCN250N0B1

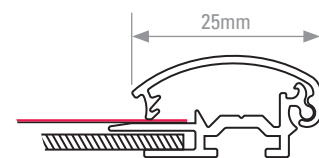

26mm Profile with Mitred or Round Corners			
Poster Size	Display Area (mm)	O/A Dimensions (mm)	Stock Status
A4	192 × 279	240 × 327	 Made to order
A3	279 × 402	327 × 450	
A2	402 × 576	450 × 624	
A1	576 × 823	624 × 871	
A0	823 × 1171	871 × 1219	
20" × 30"	490 × 744	538 × 792	
30" × 40"	744 × 998	792 × 1046	
500 × 700mm	482 × 682	530 × 730	
700 × 1000mm	682 × 982	730 × 1030	

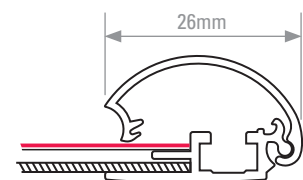

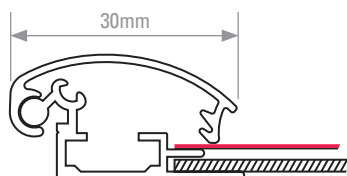

30mm Profile with Round Corners					
Poster Size	Display Area (mm)	O/A Dimensions (mm)	Weight (kg)	Stock Status	Order Code
A4	195 × 282	253 × 340	0.7	Made to order	UCN300N0A4
A3	282 × 405	340 × 463	1	Made to order	UCN300N0A3
A2	405 × 579	463 × 637	1.6	Made to order	UCN300N0A2
A1	579 × 826	637 × 884	2.8	In stock	SNRA130SA
A0	826 × 1174	884 × 1232	5.4	Made to order	UCN300N0A0
20" × 30"	493 × 747	551 × 805	2.1	In stock	SNR2330SA
30" × 40"	747 × 1001	805 × 1059	3.6	Made to order	UCN300N034
40" × 60"	1001 × 1509	1059 × 1567	6.8	Made to order	UCN300N046
500 × 700mm	485 × 685	543 × 743	2	Made to order	UCN300N0B2
700 × 1000mm	685 × 985	743 × 1043	3.4	Made to order	UCN300N0B1
1000 × 1400mm	985 × 1385	1043 × 1443	6.8	Made to order	UCN300N0B0

Also available with mitred corners (made to order).

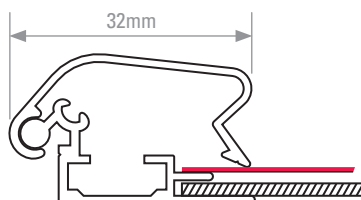

32mm Profile with Mitred or Round Corners			
Poster Size	Display Area (mm)	O/A Dimensions (mm)	Stock Status
A3	277 × 400	340 × 463	 Made to order
A2	400 × 574	463 × 637	
A1	574 × 821	637 × 884	
A0	821 × 1169	884 × 1232	
20" × 30"	488 × 742	551 × 805	
30" × 40"	742 × 996	805 × 1059	
40" × 60"	996 × 1504	1059 × 1567	
500 × 700mm	480 × 680	543 × 743	
700 × 1000mm	680 × 980	743 × 1043	
1000 × 1400mm	980 × 1380	1043 × 1443	

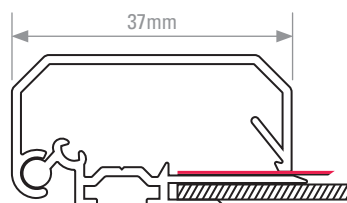

37mm Profile with Mitred Corners (wood grain finish)			
Poster Size	Display Area (mm)	O/A Dimensions (mm)	Stock Status
A3	284 × 407	343 × 466	 Made to order
A2	407 × 581	466 × 640	
A1	581 × 828	640 × 887	
A0	828 × 1176	887 × 1235	
20" × 30"	495 × 749	554 × 808	
30" × 40"	749 × 1003	808 × 1062	
40" × 60"	1003 × 1511	1062 × 1570	
500 × 700mm	487 × 687	546 × 746	
700 × 1000mm	687 × 987	746 × 1046	
1000 × 1400mm	987 × 1387	1046 × 1446	

Snapframe Chalk/Poster Boards also available. See page 46 for details.

38mm Profile with Mitred Corners					
Poster Size	Display Area (mm)	O/A Dimensions (mm)	Weight (kg)	Stock Status	Order Code
A3	266 × 389	342 × 465	1.1	Made to order	UCN385N0A3
A2	389 × 563	465 × 639	1.8	Made to order	UCN385N0A2
A1	563 × 810	639 × 886	2.9	Made to order	UCN385N0A1
A0	810 × 1158	886 × 1234	4.6	In stock	SNA038SA(W)
20" × 30"	477 × 731	553 × 807	2.1	Made to order	UCN385N023
30" × 40"	731 × 985	807 × 1061	3.9	In stock	SN3438SA(W)
40" × 60"	985 × 1493	1061 × 1569	7	In stock	SN4638SA(W)
500 × 700mm	469 × 669	545 × 745	2	Made to order	UCN385N0B2
700 × 1000mm	669 × 969	745 × 1045	3.5	Made to order	UCN385N0B1
1000 × 1400mm	969 × 1369	1045 × 1445	6.2	Made to order	UCN385N0B0

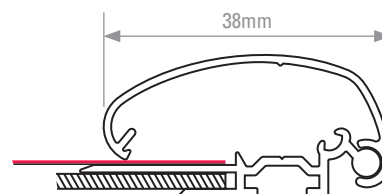

45mm Profile with Mitred Corners			
Poster Size	Display Area (mm)	O/A Dimensions (mm)	Stock Status
A3	252 × 375	340 × 463	 Made to order
A2	375 × 549	463 × 637	
A1	549 × 796	637 × 884	
A0	796 × 1144	884 × 1232	
20" × 30"	463 × 717	551 × 805	
30" × 40"	717 × 971	805 × 1059	
40" × 60"	971 × 1479	1059 × 1567	
500 × 700mm	455 × 655	543 × 743	
700 × 1000mm	655 × 955	743 × 1043	
1000 × 1400mm	955 × 1355	1043 × 1443	

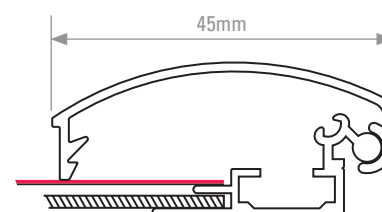

46mm Profile with Mitred or Round Corners			
Poster Size	Display Area (mm)	O/A Dimensions (mm)	Stock Status
A3	252 × 375	340 × 463	 Made to order
A2	375 × 549	463 × 637	
A1	549 × 796	637 × 884	
A0	796 × 1144	884 × 1232	
20" × 30"	463 × 717	551 × 805	
30" × 40"	717 × 971	805 × 1059	
40" × 60"	971 × 1479	1059 × 1567	
500 × 700mm	455 × 655	543 × 743	
700 × 1000mm	655 × 955	743 × 1043	
1000 × 1400mm	955 × 1355	1043 × 1443	

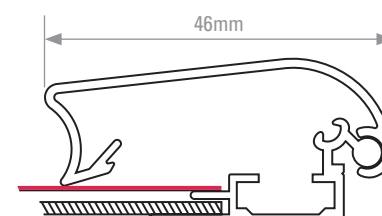

Security Snapframes

Virtually impossible to open by hand, these snapframes open easily with our hand-held opening tool (available separately)

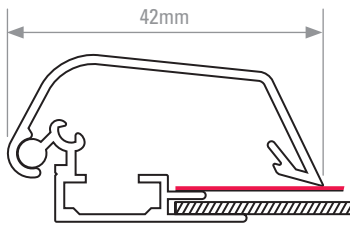
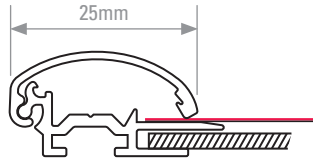

25mm Profile with Mitred Corners					
Poster Size	Display Area (mm)	O/A Dimensions (mm)	Weight (kg)	Stock Status	Order Code
A4	196 × 283	246 × 333	0.6	In stock	SNSA425SA(W)
A3	283 × 406	333 × 456	0.8	In stock	SNSA325SA(W)
A2	406 × 580	456 × 630	1.3	In stock	SNSA225SA(W)
A1	580 × 827	630 × 877	2.5	In stock	SNSA125SA(W)
A0	827 × 1175	877 × 1225	4	Made to order	UCZ255N0A0
20" × 30"	494 × 748	544 × 798	1.8	In stock	SNS2325SA(W)
30" × 40"	748 × 1002	798 × 1052	3.5	Made to order	UCZ255N034
40" × 60"	1002 × 1510	1052 × 1560	6	Made to order	UCZ255N046
500 × 700mm	486 × 686	536 × 736	1.7	Made to order	UCZ255N0B2
700 × 1000mm	686 × 986	736 × 1036	3.3	Made to order	UCZ255N0B1

Also available in custom sizes and colours through our bespoke snapframe service. See page 22 for more details.

42mm Profile with Mitred Corners					
Poster Size	Display Area (mm)	O/A Dimensions (mm)	Weight (kg)	Stock Status	Order Code
A3	256 × 379	340 × 463	1.3	Made to order	UCZ425N0A3
A2	379 × 553	463 × 637	1.9	Made to order	UCZ425N0A2
A1	553 × 800	637 × 884	2.8	Made to order	UCZ425N0A1
A0	800 × 1148	884 × 1232	4.8	In stock	SNSA042SA
20" × 30"	467 × 721	551 × 805	2.3	Made to order	UCZ425N023
30" × 40"	721 × 975	805 × 1059	4	In stock	SNS3442SA
40" × 60"	975 × 1483	1059 × 1567	7.9	In stock	SNS4642SA
500 × 700mm	459 × 659	543 × 743	2.1	Made to order	UCZ425N0B2
700 × 1000mm	659 × 959	743 × 1043	3.8	Made to order	UCZ425N0B1
1000 × 1400mm	959 × 1359	1043 × 1443	7.2	Made to order	UCZ425N0B0

Lockable Snapframes

Simple Allen key operation and sequentially opening sides keep your posters safe



Single screw on bottom edge locks all 4 sides

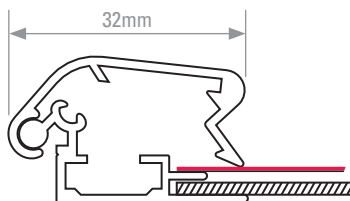

32mm Profile with Mitred Corners					
Poster Size	Display Area (mm)	O/A Dimensions (mm)	Weight (kg)	Stock Status	Order Code
A4	190 × 277	253 × 340	0.8	Made to order	UCL325N0A4
A3	277 × 400	340 × 463	1.2	In stock	SNLKA332SA
A2	400 × 574	463 × 637	1.7	In stock	SNLKA232SA
A1	574 × 821	637 × 884	3.1	In stock	SNLKA132SA
A0	821 × 1169	884 × 1232	5.6	Made to order	UCL325N0A0
20" × 30"	488 × 742	551 × 805	3.2	Made to order	UCL325N023
30" × 40"	742 × 996	805 × 1059	4	Made to order	UCL325N034
40" × 60"	996 × 1504	1059 × 1567	7.1	Made to order	UCL325N046
500 × 700mm	480 × 680	543 × 743	2.6	Made to order	UCL325N0B2
700 × 1000mm	680 × 980	743 × 1043	3.8	Made to order	UCL325N0B1
1000 × 1400mm	980 × 1380	1043 × 1443	6.2	Made to order	UCL325N0B0

Counterstand Snapframes



- Stylish poster frames with soft corners
- Optional 'clip-in' support included with each unit
- Quick and easy to change between portrait and landscape format
- Available in 2 stock sizes with choice of finishes
- Front-opening aluminium snapframes – quick and easy to change posters
- Anti-glare PET poster covers ensure clarity of message
- Includes screws and wall plugs for optional wall mounting



Silver



Black



Wood



In stock
A5 and A4

No assembly required

Recyclable
Aluminium frames and PET poster covers



Rear view showing 'clip-in' support



Front-opening aluminium snapframes for quick and easy poster change



Anti-glare PET poster covers

Specification							
Poster Size	Frame Width (mm)	Display Area (mm)	O/A Dimensions (mm)	Weight (kg)	Stock Status	Finish	Order Code
A6	14	95 × 138	126 × 169 × 13.2	0.16	Made to order	Silver	UPC145N1A6
						Black	UPC145B1A6
						Wood	UPC145W1A6
A5	14	138 × 200	169 × 231 × 13.2	0.3	In stock	Silver	OPTIA514SA
						Black	OPTIA514BLK
						Wood	OPTIA514WD
A4	25	191 × 278	241 × 328 × 17.4	0.55	In stock	Silver	OPTIA425SA
						Black	OPTIA425BLK
						Wood	OPTIA425WD

Frameworkz

Patent No. GB 2464696

Digitally printed snapframes



Unlike any other poster frames, Frameworkz snapframes can be printed with almost **any design**.

From logos and text to images and patterns, the choice is yours and the opportunities truly endless.

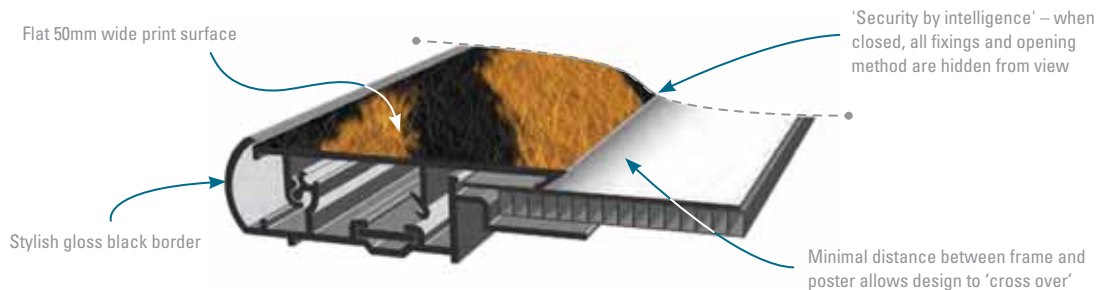

Available in virtually any size – no minimum order quantity!

- Front-opening **aluminium snapframes** for quick and easy poster change
- Suitable for external use (2-3 years in temperate climates)
- Anti-glare 500 micron **PET poster covers**
- Available with 750 micron **polycarbonate glazing panels** (additional cost applies)
- Pre-drilled ready for wall mounting



Made to order



Recyclable

Aluminium frames and PET poster covers. Mechanical fixings throughout for easy 'end of life' recycling.



Front-Opening Snapframes

Quick and easy poster change

Specification			
Poster Size	Display Area (mm)	O/A Dimensions (mm)	Profile Depth (mm)
Any size from A3 to 40" x 60"	Poster -31.5	Poster +79	15

Due to frame cutting and artwork tolerances of +/- 1mm, a visible 'step' across the mitred corners is sometimes unavoidable. Designs featuring straight lines across the corners will be particularly prone to this.

Cable Suspended Snapframes

- Double-sided poster display for floor to ceiling/wall mounting
- Front-opening snapframes (25mm) for quick and easy poster change
- Includes anti-glare PET poster covers
- Silver anodised finish as standard – also available in any RAL colour made to order (minimum order quantity: 25)

In stock
A1 snapframe
made to order



20 minutes to assemble
(subject to configuration)



Recyclable
Aluminium frames and PET poster covers

Double-Sided Snapframes – 25mm Profile with Mitred Corners					
Poster Size	Display Area (mm)	O/A Dimensions (mm)	Weight (kg)	Stock Status	Order Code
A4	192 × 279	240 × 327	0.9	In stock	SNDSA425SA
A3	279 × 402	327 × 450	1.5	In stock	SNDSA325SA
A2	402 × 576	450 × 624	2.1	In stock	SNDSA225SA
A1	576 × 823	624 × 871	3.1	Made to order	UCD255N2A1

Wire System Components		
Item	Stock Status	Order Code
Stopper for Frames	In stock	FASF
Ceiling/Floor Hanger		FACFH
Cable		FAWC
Basic Ceiling Hanger		FACH



Snapframe Bracketry for Shelving Systems

If one of our standard brackets or fixture solutions doesn't fit the bill then we can design one that will – one which integrates our market-leading poster frames into your shelving and fixturing system in exactly the way you want.

We have brackets that will allow you to clip frames into system uprights, mount to shelf and gondola end capping or suspend with wirework.

Call us for further information or to discuss your ideas.



Made to order



Double-sided 15mm snapframe with legs bolted to gondola end capping



Custom snapframe bolted to gondola end capping



Black finish snapframes mounted using vertical system brackets



Vertical system bracket on 25mm snapframe

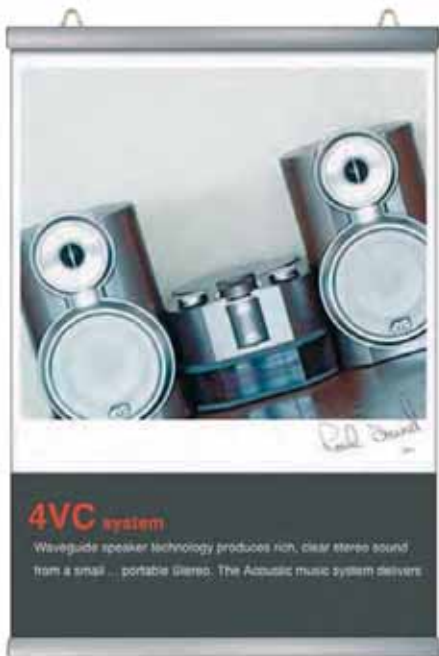

Adjustable hanging clips



Poster Snap

Lightweight display solution for paper posters

- Each set consists of a pair of 26mm aluminium snapframe rails with black end caps and adjustable hanging clips
- Can be wall mounted or suspended for window display
- Silver anodised finish as standard – also available in any RAL colour (minimum order quantity: 100)



In stock
Certain sizes
made to order



No assembly required



Recyclable
Aluminium snapframe rails

Specification			
Poster Width (mm)	Weight (kg)	Stock Status	Order Code
210 (e.g. A5 or A4)	0.15	Made to order	UPT26SN021
300 (e.g. A4 or A3)	0.2	In stock	PS30
420 (e.g. A3 or A2)	0.25	In stock	PS420
500	0.3	In stock	PS50
600 (e.g. A2 or A1)	0.4	In stock	PS594
700	0.45	Made to order	UPT26SN070
850 (e.g. A1 or A0)	0.5	In stock	PS841
1000	0.6	Made to order	UPT26SN100

Available in custom sizes made to order (minimum order quantities apply).



Open clamp...



...insert poster...



...and close clamp

Poster Clamp

Heavy duty gripping action for materials up to 500 micron (0.5mm) thick

- Ideal for large/heavy weight posters or banners
- Each set consists of a pair of 2-part 25mm aluminium rails
- Silver anodised finish as standard – also available in any RAL colour (minimum order quantity: 100)



In stock
Certain sizes
made to order



No assembly required



Recyclable
Aluminium rails

Specification			
Poster/Banner Width (mm)	Weight (kg)	Stock Status	Order Code
210 (e.g. A5 or A4)	0.26	Made to order	UPC10SN021
300 (e.g. A4 or A3)	0.29	Made to order	UPC10SN030
420 (e.g. A3 or A2)	0.4	Made to order	UPC10SN042
500	0.5	In stock	PC500(M)
600 (e.g. A2 or A1)	0.5	Made to order	UPC10SN060
700	0.65	In stock	PC700(M)
850 (e.g. A1 or A0)	0.75	Made to order	UPC10SN085
1000	0.95	In stock	PC1000(M)
1200	1	Made to order	UPC10SN120

Available in custom sizes made to order (minimum order quantities apply).

Poster Hanger

Perfect for paper, card, flexible banner materials and rigid plastics

- Suitable for materials up to 1mm thick
- Use hooks or line (not included) to create a great looking display in any retail environment
- Silver anodised finish as standard – also available in any RAL colour (minimum order quantity: 100)

 **In stock**
Certain sizes made to order

 **No assembly required**

 **Recyclable**
Aluminium rails



Each set consists of:

- 2 aluminium rails (20mm wide) with black swivel end caps and poster/banner grippers (2 or 3 per rail depending on size)
- Adjustable hanging clips on top rail (suitable for wall mounting)



Remove grippers from rail...



...push onto poster...

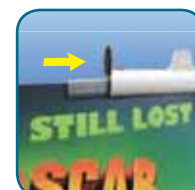

...and insert back into rail

Specification			
Poster/Panel Width (mm)	Weight (kg)	Stock Status	Order Code
210 (e.g. A5 or A4)	0.1	Made to order	UPF21SN021
300 (e.g. A4 or A3)	0.15	Made to order	UPF21SN030
420 (e.g. A3 or A2)	0.2	In stock	PFX420
500	0.22	Made to order	UPF21SN050
600 (e.g. A2 or A1)	0.25	In stock	PFX594
700	0.3	Made to order	UPF21SN070
850 (e.g. A1 or A0)	0.35	In stock	PFX841
1000	0.4	Made to order	UPF21SN100
1016 (e.g. 30" x 40" or 40" x 60")	0.45	In stock	PFX1016
1200	0.5	Made to order	UPF21SN120

Available in custom sizes made to order (minimum order quantities apply).

Snapframe Rails with Back Panels

The combination of 2 aluminium snapframe rails mounted on to a formed steel back panel creates a simple, stylish and highly effective poster display.

Snapframe Rails with Back Panels can be made to virtually any size and in any RAL colour (silver anodised as standard). All Snapframe Rails with Back Panels are made to order.



Triple A1



Single A1

 **Made to order**
Minimum order quantity: 50

 **Recyclable**
Aluminium snapframe rails and steel back panels



Stretch Frames

Contemporary and lightweight single or double-sided poster display

- Silver anodised aluminium frame (10 x 7mm)
- Spring mounted clips hold posters securely in place
- Adjustable hangers (included) allow for wall, ceiling or window mounting (suction hooks also required for window mounting)
- Also available in custom sizes and colours (minimum order quantity: 50)



Made to order



No tools assembly



2 minutes to assemble



Recyclable
Aluminium frame

Specification			
Poster Size	O/A Dimensions (mm)	Weight (kg)	Order Code
A4	310 x 397 x 10	0.22	UPSCN000A4
A3	397 x 520 x 10	0.27	UPSCN000A3
A2	520 x 694 x 10	0.35	UPSCN000A2
A1	694 x 941 x 10	0.45	UPSCN000A1



Magnetic seals for quick and easy poster change



Custom designs also available (minimum order quantities apply)

Headliner

High visibility poster display for windows and doors

- Mount directly to inside of glass – no need for messy sellotape or blu-tack!
- Prime position permanent brand presence
- Hard-wearing PVC poster wallet with magnetic seals ensures posters stay clean, dry and presentable
- Available with square or round corners, with or without header
- Borders printed with your choice of colour/artwork

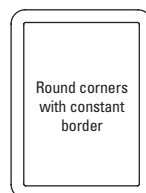

Round corners with constant border

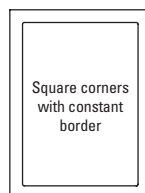

Square corners with constant border

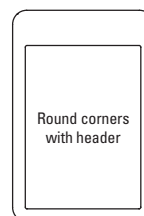

Round corners with header

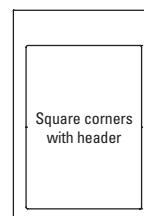

Square corners with header

Standard sizes: A4, A3, A2, A1 and 20" x 30" (minimum order quantity: 25).

Bespoke sizes also available (minimum order quantity of 100 and one-off cutter charge applies).



Made to order
Minimum order quantity: 25



No assembly required

Media Frame

Totally secure, virtually indestructible interior poster display

- Heavy duty aluminium frame with virtually indestructible PET glazing panel
- Frames available in any RAL colour and with optional pad-printed logos
- Moisture-resistant MDF back panel
- Available in sizes from A4
- Easy to update using Allen key provided



Made to order
Minimum order quantity: 50



No assembly required



Recyclable
Aluminium frame and PET glazing panel



Media Frame is ideal for use in pub, bar and restaurant toilets – effective, targeted advertising



Slide-In Poster Frames

Double-sided poster display for wall mounting or hanging

- Silver anodised aluminium frames (25mm profile)
- Easy 'slide in, slide out' poster change
- Suitable for landscape or portrait display
- Supplied with anti-glare PET poster cover sheets
- Adjustable hangers included
- Also available in custom sizes and colours (minimum order quantity: 50)



Made to order



No assembly required



Recyclable
Aluminium frames and PET poster cover sheets



Specification					
Poster Size	Display Area (w × h × d mm)	O/A Dimensions (w × h × d mm)	Weight (kg)	Order Code	
				Portrait	Landscape
A4	174 × 261	224 × 311 × 15	0.5	UCS255N1A4	UCS255N2A4
A3	261 × 384	311 × 434 × 15	0.8	UCS255N1A3	UCS255N2A3
A2	384 × 558	434 × 608 × 15	1.2	UCS255N1A2	UCS255N2A2
A1	558 × 805	608 × 855 × 15	1.9	UCS255N1A1	UCS255N2A1

Showboard with Felt

High quality felt notice boards in a range of sizes and colours

- Suitable for internal use in portrait or landscape format
- Available in 4 sizes with red, blue, green or grey felt backing
- Suitable for use with Velcro and pins
- Silver anodised aluminium frames (profile width: 45mm) with PETG glazing panels and galvanised steel back panels
- Locking doors for security (1 lock on 4 x A4 size, 2 locks on all other sizes)
- Supplied complete with set of pins, screws, wall plugs and pair of keys



Made to order



No assembly required



Recyclable

Aluminium frames, galvanised steel back panels and PETG glazing panels



Specification					
Size	Display Area (mm)	O/A Dimensions (w x h x d mm)	Weight (kg)	Felt Colour	Order Code
4 x A4	483 x 653	585 x 755 x 36	8.5	Red	USBN1104A4
				Blue	USBN1204A4
				Green	USBN1304A4
				Grey	USBN1404A4
6 x A4	483 x 973	585 x 1075 x 36	10.4	Red	USBN1106A4
				Blue	USBN1206A4
				Green	USBN1306A4
				Grey	USBN1406A4
9 x A4	713 x 973	815 x 1075 x 36	14.1	Red	USBN1109A4
				Blue	USBN1209A4
				Green	USBN1309A4
				Grey	USBN1409A4
12 x A4	943 x 973	1045 x 1075 x 36	18	Red	USBN1112A4
				Blue	USBN1212A4
				Green	USBN1312A4
				Grey	USBN1412A4

Slimlok 3

A range of stylish poster display cases with lockable doors

All models feature:

- Durable **aluminium frames** (52 x 30mm, silver anodised finish) and vandal resistant **glazing panels** (1.5mm polycarbonate)
- Suitable for internal and external use, landscape or portrait



In stock



No assembly required



Recyclable

Aluminium frames and polycarbonate glazing panels



Durable aluminium frames



All models supplied complete with set of keys



Custom sizes and colours available (minimum order quantities apply)



Poster Case

NEW!

Poster Case

Noticeboard

Menu Case

Illuminated Menu Case



Page 38



Page 39





Poster Case



Optional door stays on larger models (from A1 upwards)



Internal clips hold posters securely in place and allow quick and easy poster change

Specification					
Poster Size	Display Area (mm)	O/A Dimensions (w x h x d mm)	Weight (kg)	Door Stays	Order Code
A4	186 x 273	291 x 378 x 32	2	–	SKA4MK3
A3	273 x 396	378 x 501 x 32	2.5	–	SKA3MK3
A2	396 x 570	501 x 675 x 32	3.5	–	SKA2MK3
A1	570 x 817	675 x 922 x 32	6	Optional	SKA1MK3
A0	817 x 1165	922 x 1270 x 32	9	Optional	SKA0MK3
20" x 30"	484 x 738	589 x 843 x 32	5	–	SK2030MK3
30" x 40"	738 x 992	843 x 1097 x 32	8	Optional	SK3040MK3
40" x 60"	992 x 1500	1097 x 1605 x 32	13	Optional	SK4060MK3

Also available in custom sizes and colours (no minimum order quantity).

Available in a wide range of stock sizes:

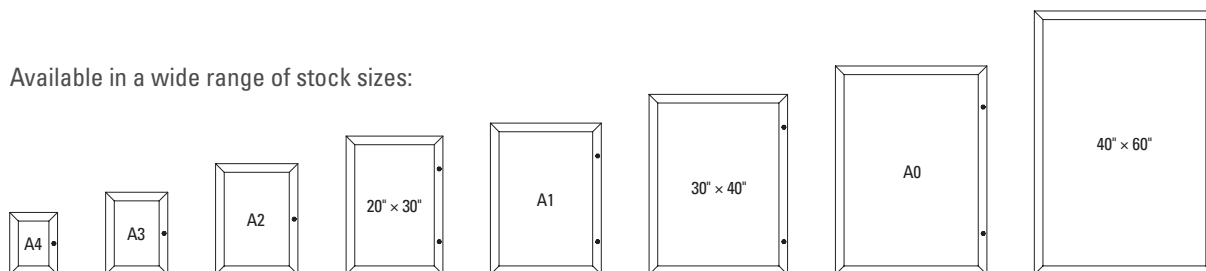

All sizes also available with additional header area, for self-adhesive vinyl or direct-to-surface-print



Noticeboard

Featuring a magnetic/dry-wipe back panel

Available in 4 stock sizes:

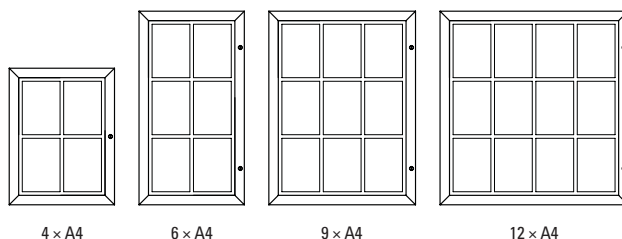

Door stays fitted as standard on all models



Supplied with set of magnetic pins

Specification			
Size	O/A Dimensions (w x h x d mm)	Weight (kg)	Order Code
4 x A4	585 x 759 x 32	6.4	NB4XA4MK3
6 x A4	585 x 1076 x 32	8	NB6XA4MK3
9 x A4	815 x 1076 x 32	12	NB9XA4MK3
12 x A4	1045 x 1076 x 32	14.8	NB12XA4MK3

Also available in custom sizes and colours (minimum order quantity for custom sizes: 5).

Menu Case

Featuring a magnetic/dry-wipe back panel and additional header area

Available in 4 stock sizes:

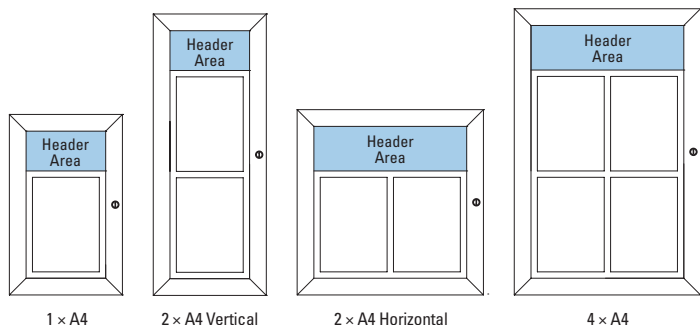

Glazing panels suitable for self-adhesive vinyl or direct-to-surface print

Specification				
Size/Format	O/A Dimensions (w x h x d mm)	Header Area (mm)	Weight (kg)	Order Code
1 x A4	355 x 567 x 32	251 x 125	3	SKMC1XA4MK3
2 x A4 Vertical	355 x 884 x 32		5	SKMC2XA4VERTMK3
2 x A4 Horizontal	585 x 579 x 32	481 x 140	5	SKMC2XA4HORIMK3
4 x A4*	585 x 899 x 32		7	SKMC4XA4MK3

Also available in custom sizes (minimum order quantity: 5) and colours. *Door stays fitted as standard.



Door stays fitted as standard on 4 x A4 model



Supplied with set of magnetic pins

Illuminated Menu Case

All the features of our Menu Case plus LED illumination

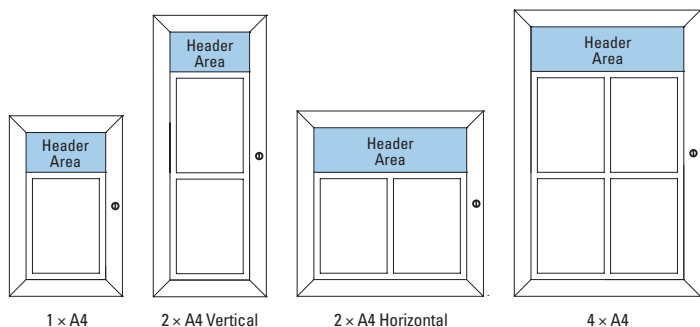

Glazing panels suitable for self-adhesive vinyl or direct-to-surface print



LED strip along top inside edge



12V adaptor supplied with each unit



3m waterproof extension cables enable flexible positioning



LED illumination...

- Bright, even and long-lasting – 50,000+ hours life!
- Low-voltage – low power consumption and completely safe
- No need for qualified electrician to install
- No risk of bulb breakages – maintenance free

Specification				
Size/Format	O/A Dimensions (w x h x d mm)	Header Area (mm)	Weight (kg)	Order Code
1 x A4	355 x 567 x 32	251 x 125	3.5	SKILLMC1XA4MK3
2 x A4 Vertical	355 x 884 x 32		5.5	SKILLMC2XA4VERTMK3
2 x A4 Horizontal	585 x 579 x 32	481 x 140	5.5	SKILLMC2XA4HORIMK3
4 x A4*	585 x 899 x 32		7.5	SKILLMC4XA4MK3

Also available in custom sizes (minimum order quantity: 25) and colours. *Door stays fitted as standard.

Hi-Sight

EU Design Registration No. 000879846

Thanks to its unique 'pull-down' poster cartridge, Hi-Sight has many advantages over traditional poster frames...

- Can be mounted up to 3 × higher
- Quicker, easier and safer – no need to stretch or use ladders
- Reduced risk of tampering and vandalism
- Hard-wearing **aluminium frame**
- Fixed **polycarbonate poster cover** with magnetic seals – virtually no risk of poster loss
- Excellent weather resistance
- Suitable for indoor and outdoor use
- Hidden pre-drilled holes, ready for wall mounting



In stock



No assembly required



Recyclable

Aluminium frame and polycarbonate poster cover



Ideal for out-of-town retailers, Hi-Sight maximises the visibility of store-front promotions – vital in the drive for greater awareness and increased sales.



Traditional frames – low visibility



Hi-Sight – high visibility!



Pull-down poster cartridge for safe, quick and easy poster change



Apply finger pressure just above border and lift



Poster cover security fixings



Internal frame detail

Posters are held in place by 4 'pinch' holders on top of cartridge



Open 'poster-pinch' mounts to add or change posters



Place poster within 'poster-pinch' opening



Close 'poster-pinch' mounts to pierce and grip poster

Specification				
Poster Size	Display Area (mm)	O/A Dimensions (mm)	Weight (kg)	Order Code
A0	830 × 1163	937 × 1295	8.4	HISA0SA(S)
30" × 40"	751 × 990	858 × 1122	7.2	HIS34SA(S)
40" × 60"	1005 × 1498	1112 × 1630	12	HIS46SA(S)

Also available with custom colour borders (minimum order quantity: 25).
6 sheet size also available (minimum order quantities apply).



Double-sided Info Board with Acrylic Brochure Shelves

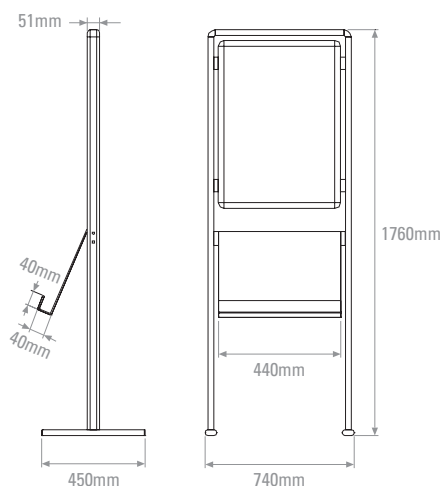

Info Board

- A1 poster display, single or double-sided
- Front-opening aluminium snapframes for quick and easy poster change (silver anodised finish)
- Anti-glare PET poster covers
- Illuminated option also available (see page 75)
- Optional acrylic brochure shelves, available separately (see below)



In stock



10 minutes to assemble



Recyclable

Aluminium snapframes, aluminium stand and PET poster covers



Optional wheels



Anti-glare poster covers

Specification				
Poster Size	O/A Dimensions (w × h × d mm)	Sides	Weight (kg)	Order Code
A1	740 × 1760 × 450	Single	8.8	INFOSGA1
		Double	11.1	INFODSA1



Acrylic Brochure Shelves for Info Board

- Made with crystal clear 4mm acrylic
- Single or double-sided, for 2 or 4 × A4 brochures respectively



In stock



Recyclable
Acrylic shelves

Specification				
Shelf Type	Capacity	Dimensions (w × d mm)	Weight (kg)	Order Code
Single-sided	2 × A4	440 × 40	1	INFOSHLFSG
Double-sided	4 × A4	440 × 40	2	INFOSHLFDS

Budget Info Board



Single Tier



Double Tier



Large Single

- Simple, functional, low cost design
- Posters/panels simply slide into place
- **Aluminium frames** with choice of silver anodised or black powder coated finish
- Black **polystyrene (HIPS) inner sheets** provide light block between posters
- Protective **PET poster cover sheets**
- Allen key and instructions supplied with each unit

Simple assembly method...



Specification					
Type	Poster/Panel Size (mm)	Display Area (mm)	O/A Dimensions (w x h x d mm)	Finish	Order Code
Single Tier	500 x 700	472 x 672	562 x 1595 x 380	Silver	UIBS00N1B2
				Black	UIBS00C1B2
	594 x 841 (A1)	566 x 813	656 x 1595 x 380	Silver	UIBS00N1A1
				Black	UIBS00C1A1
Double Tier	500 x 700 (x2)	472 x 672 (x2)	562 x 1595 x 380	Silver	UIBS00N2B2
				Black	UIBS00C2B2
	594 x 841 (x2)	566 x 813 (x2)	656 x 1820 x 450	Silver	UIBS00N2A1
				Black	UIBS00C2A1
Large Single	500 x 1700	472 x 1672	561 x 1895 x 380	Silver	UIBS00N151
				Black	UIBS00C151



Made to order



5 minutes to assemble



Recyclable
Aluminium frames, PET poster covers and polystyrene (HIPS) inner sheets

GripChalkers

Available in 2 stock sizes, these simple yet stylish table top chalkboards feature our spring-powered 'grip-action' bases



HPL Chalkboard Panels

- 3mm 'High Pressure Laminate' with round tops as standard
- Suitable for soft chalk and liquid chalk pens
- Printed and square top panels available made to order, with optional handle cut-outs (minimum order quantity: 100)

Bases

- **Aluminium** with silver anodised finish as standard
- Spring-powered 'grip-action' – simply open by hand, insert panel and release
- Suitable for self-adhesive vinyl, 'polydome stickers' or pad-printed graphics*
- Available in custom sizes, colours and finishes made to order (minimum order quantity: 100)

*Maximum pad-print height: 15mm

Other Display Options:

These bases are suitable for almost any rigid sheet material between 1-4mm thick. E.g. acrylic, PVC, PET and foam PVC.

Printed panels available made to order (minimum order quantity: 25)



With printed panels and pad-printed bases



Simply grip the base open and insert the chalkboard



Spring-powered 'grip-action' bases



In stock



No tools assembly



Recyclable
Aluminium bases

Specification

Size	Base Dimensions (w x h x d mm)	O/A Height with Panel (mm)	Part	Display Area (mm)	Weight (kg)	Order Code
A5	148 x 18 x 84	222	Base only	–	0.8	SWBASEA5
			HPL panel	148 x 201	1.4	HPLTABLECHALKA5
A4	210 x 18 x 84	309	Base only	–	1	SWBASEA4
			HPL panel	210 x 288	2.8	HPLTABLECHALKA4

HPL

See page 47 for more details

- Stays looking newer for longer
- Never needs re-painting
- Easy to clean
- Anti-glare surface ensures clarity
- Weather and scratch resistant

To view our range of **Chalkboard Pavement Signs and A-Boards**, see pages 13, 14, 17, 18 and 19



Budget Framed Chalkboards

Low price, high perceived value interior chalkboards

- MDF frames with dark 'mahogany' finish
- Black painted hardboard back panels
- Suitable for interior use only
- Individually packed with pair of 'O' screws



In stock



No assembly required



Recycled materials
MDF frame and hardboard back panel
manufactured from recycled timber



Specification					
Size	Display Area (w x h mm)	O/A Dimensions (w x h x d mm)	Frame Width (mm)	Weight (kg)	Order Code
Small	250 x 350	290 x 390 x 16	20	0.8	CHK30X40
Medium	310 x 510	390 x 590 x 16	40	1.8	CHK40X60
Large	500 x 800	590 x 890 x 24	45	4	CHK60X90

Alternative frame finishes and custom sizes available (minimum order quantities apply).

Slatted Chain Board

Unique design featuring individual panels which can be removed without interfering with the rest of the display

- HPL chalkboard panels, suitable for traditional chalk or liquid chalk pens
- 6 x 3mm slats, each with 500 x 83mm writing area
- Reverse individual slats or whole board
- Overall size: 550 x 935mm (header 210mm deep at centre)



Fixing holes in header panel – ideal for wall-mounting



Also suitable for double-sided display



Individually reversible slats



With printed header and footer panels



Made to order
Minimum order quantity: 10



Recyclable
Steel chains

Slatted Magnetic Board

Magnetic strips allow individual slats to be removed and rearranged in seconds

- HPL chalkboard panels, suitable for traditional chalk or liquid chalk pens
- 6 x 2mm slats, each with 500 x 85mm writing area
- 3mm back panel provides header and footer space for additional message/branding, plus option to reverse for single panel display
- Overall size: 500 x 800mm



Individual magnetic slats



Reverse for single chalkboard display



With printed header and footer



Made to order
Minimum order quantity: 10

Snapframe Chalk/Poster Boards

Quick and easy to change between poster and chalkboard display



Open snapframe sides and remove chalkboard



Place poster and cover sheet in front



Close snapframe sides

- Front-opening **aluminium snapframes** for quick and easy poster change
- Reversible HPL chalkboard panel (2mm) included with each unit
- High quality **polycarbonate poster covers** (0.75mm thick) – stored behind chalkboard when not in use
- ‘Security by intelligence’ – when closed, all fixings and opening method are hidden from view
- Suitable for internal and external use
- Individually packed with instructions and screws/wall plugs



In stock



No assembly required



Recyclable

Aluminium snapframes and polycarbonate poster covers



Available with Wood, Polished Silver and Gold finish frames in A3, A2 and A1 poster sizes

Specification						
Finish	Profile	Panel/Poster Size	Display Area (mm)	O/A Dimensions (mm)	Weight (kg)	Order Code
Wood		A3	284 × 407	343 × 466	1.5	SNA3CHALK/WOOD
		A2	407 × 581	466 × 640	2.5	SNA2CHALK/WOOD
		A1	581 × 828	640 × 887	4.5	SNA1CHALK/WOOD
Polished Silver		A3	266 × 389	344 × 467	1.5	SNA3CHALK/SILVER
		A2	389 × 563	467 × 641	2.5	SNA2CHALK/SILVER
		A1	563 × 810	641 × 888	4.5	SNA1CHALK/SILVER
Gold		A3	266 × 389	344 × 467	1.5	SNA3CHALK/GOLD
		A2	389 × 563	467 × 641	2.5	SNA2CHALK/GOLD
		A1	563 × 810	641 × 888	4.5	SNA1CHALK/GOLD

Alternative finishes and custom sizes available (minimum order quantity: 25).

HPL Chalkboards



- Available in 2, 3, 4 and 6mm thicknesses
- Virtually any size and shape
- Drilled ready for wall mounting
- Available plain or printed, single or double-sided



Made to order
Minimum order quantity: 10



About HPL

Our remarkable 'High Pressure Laminate' (HPL) chalkboard material is a high quality phenolic resin based laminate capable of almost limitless use and application.

- **Stays looking new** for longer and **never needs re-painting!**
- **Easy to clean** with water and household cleaner
- **Weather and scratch resistant** anti-glare surface
- Suitable for use with traditional chalk and liquid chalk pens
- Direct-to-surface screen and digital **printing available**
- Available in a range of thicknesses: 2, 3, 4 and 6mm

HPL's **hard-wearing**, virtually **maintenance free** properties make it ideal for both **internal and external** use whilst the specially formulated melamine impregnated surface layer means your chalkboards **stay looking new** long after conventional alternatives have faded.

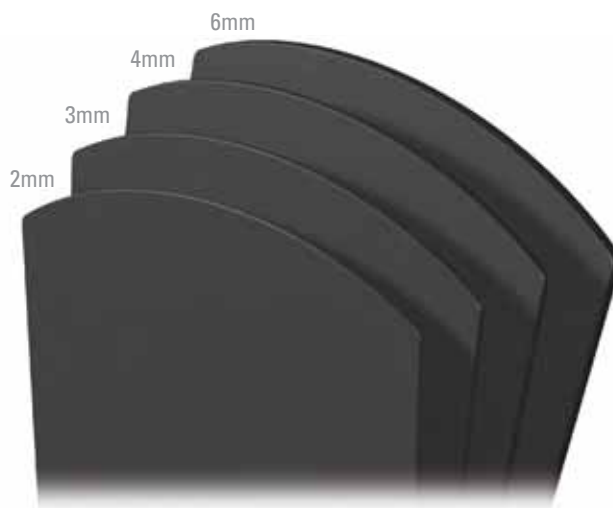

Chalk Pens

Rainbow liquid wet wipe 'chalk' can be removed with a damp cloth yet is waterproof and permanent under even the heaviest rainfall. This makes it ideal for situations where the finished work might come into contact with dampness or water.

- Rainproof after just 1 hour yet erasable with a damp cloth
- Our independent tests have conclusively shown these chalk pens provide superior colour vibrancy and outdoor durability
- Any staining following prolonged use can be removed using conventional household cleaner (e.g. Mr Muscle)



In stock

Specification

Nib Size (mm)	Pack Quantity	Colour(s)	Order Code
5 (small)	5	Assorted*	CHALKPENSET1
15 (large)	3	White	CHALKPENSET2

*Contains: red, green, white, yellow and blue.

Sentinel®

EU Design Registration No. 000190954

The Ultimate Forecourt Poster Sign

External poster signage is a powerful advertising tool. With 70% of purchase decisions made in-store, driving footfall into the store is obviously key. And nothing does that better than targeted, high impact poster advertising outside the store. The use of strong graphics displayed in a well designed sign will ensure that first impressions count for success.



Magnetic poster covers for quick and easy poster change



Coloured/printed borders available (minimum order quantity: 25)



Custom colour bases available (minimum order quantity: 100)

Now available in 3 stock sizes:



30" x 40"

NEW! A0

40" x 60"

Sentinel working hard for major retailers across the country

Specification				
Poster Size	O/A Dimensions (w x h x d mm)	Display Area (mm)	Weight (kg) Empty/Full	Order Code
30" x 40"	935 x 1429 x 704	754 x 1008	27/99	SEN34MK4GG
A0	979 x 1603 x 704	820 x 1169	31/103	SENA0MK4GG
40" x 60"	1171 x 1942 x 894	995 x 1503	57/169	SEN46MK4GG



In stock



Recyclable

Steel frame, polycarbonate poster covers and part recycled polyethylene base



8 minutes to assemble and fill base

Ideally by 2 people

Also available in custom colours (minimum order quantities apply).

Trolley & Hose for Sentinel®, Sightmaster 2 and Cyclone 2

The purpose-designed trolley enables easy and safe movement of Sentinel, Sightmaster 2 and Cyclone 2 forecourt signs, whilst the hose gives convenient assistance for filling bases with water. The adaptor is for use with Sightmaster 2 only.



Moving Sentinel couldn't be easier with our purpose-designed trolley

Specification			
Item	O/A Dimensions (mm)	Weight (kg)	Order Code
Trolley	225 x 1220 x 225	2.5	TROLLEY
Adaptor	90 x 45 x 48	0.125	TROLLEYADAPTOR
Hose	5000 x 13	1	SENHOSE



In stock

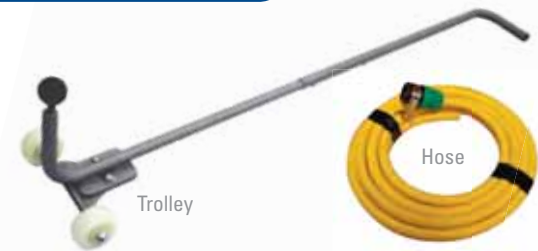

Trolley

Hose

Tactical Header for Sentinel®

- Simply clips onto Sentinel frames
- Ideal for short-term promotions – additional advertising site for minimal cost
- Gloss white PVC/polypropylene panel, ideal for screen/digitally printed graphics or vinyl application



Made to order
Clips held in stock



Recyclable
PVC/polypropylene panel

Headers can create eye-catching silhouettes and added 'theatre'

Sightmaster Pro



Patent No. PCT/TR09/000148

Striking 'all black' snapframe poster sign

- Front-opening aluminium snapframes for quick and easy poster change
- Water-fillable LLDPE base for optimum stability
- Built-in wheels for ease of movement
- Heavy duty mounts ensure stability by allowing panel deflection in the wind
- Anti-glare PET poster covers ensure clarity of message
- Soft round corners for safety



In stock
A1



10 minutes to assemble and fill base



Recyclable
Aluminium frames, PET poster covers and LLDPE base

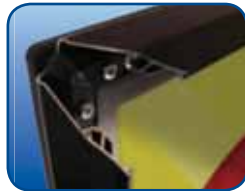

Front-opening snapframes for quick and easy poster change



Water-fillable base for optimum stability



Built-in wheels for ease of movement

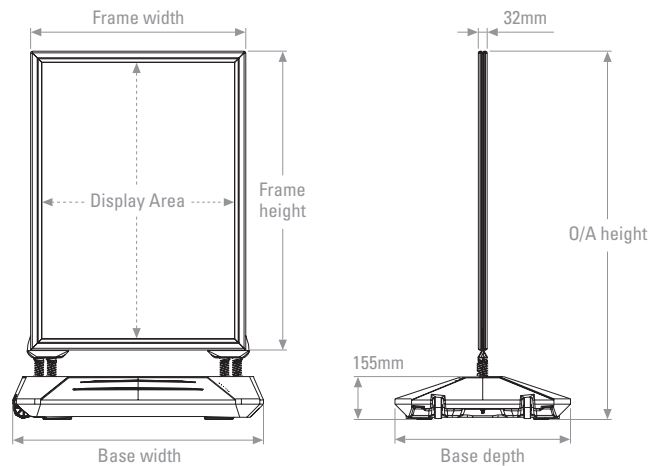

Specification								
Poster Size	Display Area (mm)	Dimensions (mm)			Weight (kg)		Stock Status	Order Code
		Base (w x d)	Frame (w x h)	O/A Height	Packaged	Assembled Empty/Full		
A1	586 x 833	720 x 580	666 x 913	1165	14.9	11.5/41.5	In stock	ECWVMA1MB/F
A0	833 x 1181	900 x 630	913 x 1261	1510	20	16.6/53.1	Made to order	UTWM/USWPA0
20" x 30"	500 x 754	720 x 580	580 x 834	1085	14.6	11.2/41.2		UTWM/USWP23
30" x 40"	754 x 1008	900 x 630	834 x 1088	1340	20	16.6/53.1		UTWM/USWP34
500 x 700mm	492 x 692	720 x 580	572 x 772	1020	14.3	10.9/40.9		UTWM/USWPB2
700 x 1000mm	692 x 992	900 x 630	772 x 1072	1320	19.1	15.7/52.5		UTWM/USWPB1

Sightmaster 2

Stylish snapframe forecourt sign in a range of poster sizes

- Front-opening **aluminium snapframes** for quick and easy poster change
- Rigid 'kick proof' **ACM back panel**, suitable for dry-wipe and liquid chalk pens
- Water-fillable **HDPE base** with built-in wheels and carry handle
- Heavy duty mounts ensure stability by allowing panel deflection in the wind
- Anti-glare **PET poster covers** ensure clarity of message
- Soft round corners for safety



In stock



6 minutes to assemble and fill base



Recyclable Aluminium frames, aluminium composite back panel, PET poster covers, steel brackets and HDPE base. Mechanical fixings throughout for easy 'end of life' recycling.



Built-in wheels for ease of movement



Snapframe opening tool (left) and 2-piece spanner (right) included with each unit



Purpose-designed trolley available separately (see page 49 for details)



Available in 3 stock poster sizes

Specification						
Poster Size	Display Area (w × h mm)	O/A Dimensions (w × h × d mm)	Frame Size (w × h mm)	Base Dimensions (w × h mm)	Weight (kg) Empty/Full	Order Code
A1	576 × 821	800 × 1193 × 505	646 × 893	800 × 505	18/37	ECWWWMA1HB/SC
A0	823 × 1173	960 × 1559 × 610	893 × 1240	960 × 610	25/77	ECWWWMA0HB/SC
30" × 40"	744 × 997	960 × 1386 × 610	814 × 1068	960 × 610	23/76	ECWWWM34HB/SC

Cyclone 2

Patent No. GB 2464696

Stable and stylish, robust and refined

- Double-sided 40" × 60" poster display
- Front-opening aluminium snapframes for quick and easy poster change
- White 'Frameworkz' frames as standard – available printed or suitable for vinyl application (see page 30)
- 700 micron PET poster covers give excellent clarity, fixed along top edge for ease of poster change
- Steel cradle with hard-wearing pivots allows panel to move in the wind
- Robust water-fillable HDPE base for optimum stability
- Built-in wheels for ease of movement
- Round corners throughout for safety



In stock



8 minutes to assemble and fill base
Ideally by 2 people



Recyclable
Aluminium frames, steel cradle, PET poster covers, polypropylene back panels and part-recycled HDPE base



Cyclone 2's counter-balanced panel deflects wind safely and creates interest through movement...

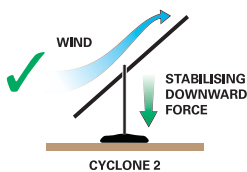

CYCLONE 2

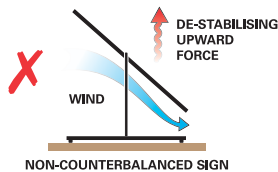

NON-COUNTERBALANCED SIGN

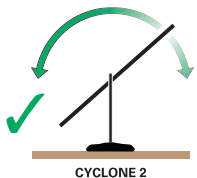

CYCLONE 2



BASE PIVOTED SIGN



Recommended method of moving once filled (trolley available separately)



Front-opening snapframes for ease of poster change



Frames available printed or suitable for vinyl application



Water-fillable base for optimum stability



Hard-wearing pivots allow panel to move in the wind



Built-in wheels for ease of movement

Specification				
Poster Size	Display Area (w × h mm)	O/A Dimensions (w × h × d mm)	Weight (kg) Empty/Full	Order Code
40" × 60"	984 × 1492	1206 × 1831 × 698	44.5/99.5	CYCLONE2

Defender

Permanent large format poster display

- Front-opening aluminium snapframes (38mm profile) for quick and easy poster change
- Anti-glare PET poster covers give excellent clarity
- Heavy concrete bases guarantee stability with a minimal footprint
- Steel sub-frame with panel area below poster frame suitable for permanent branding
- Silver anodised finish as standard – also available in custom colours (minimum order quantities apply)



In stock



8 minutes to assemble
Ideally by 2 people



Recyclable

Aluminium snapframes, steel sub-frame and PET poster covers

Specification				
Poster Size	Display Area (w × h mm)	O/A Dimensions (w × h mm)	Weight (kg) inc. base	Order Code
30" × 40"	733 × 987	818 × 1447	71	DEF34WA
40" × 60"	987 × 1495	1072 × 1855	112	DEF46WA



30" × 40" size shown.
Also available for 40" × 60" posters.

Sentinel® Banner

Our market-leading forecourt sign with printed banner display

- Steel frame with silver anodised finish as standard – also available in custom colours (minimum order quantity: 25)
- Water-fillable polyethylene base precisely calculated for optimum stability (made using recycled materials)
- Black base as standard to hide dirt and marks – also available in custom colours (minimum order quantity: 100)
- Built-in wheels – easy to move with our purpose-designed trolley
- Supplied complete with set of elasticated banner ties
- Digitally printed banners available to order (750gsm reinforced light block PVC as standard)



In stock



8 minutes to assemble and fill base
Ideally by 2 people



Recyclable

Steel frame, part recycled polyethylene base and optional reinforced PVC banner

Specification				
Banner Size (mm)	O/A Dimensions (w × h × d mm)	Weight (kg) Empty/Full	Stock Colour Frame/Base	Order Code
742 × 996	935 × 1429 × 704	25/97	Silver/Black	SENBAN34GG
996 × 1504	1171 × 1942 × 894	38/150		SENBAN46GG



Elasticated banner ties supplied



Hose and purpose-designed trolley available separately. See page 49 for details.

Curved Pop-Ups

Portable Exhibition Stands

- High impact, low cost
- Quick and easy to assemble
- Sturdy, durable and long lasting

Each kit includes:

- Collapsible aluminium frame (12mm diameter, silver finish) with black injection moulded fittings
- Set of magnetic bars and roll of magnetic 'B' tape
- Roll of magnetic 'A' tape (for vertical panel edges)
- 2 x 150W clip-on spotlights with cable and plug
- Semi-rigid trolley/case with built-in wheels

Optional Printed Panels

- 420 micron opaque white PVC
- Supplied ready to fit with 'kick-strips' pre-applied
- Available laminated (80 micron matt textured scratch resistant PVC)



Curved Pop-Ups can create a powerful 'brand backdrop'



In stock



No tools assembly



10 minutes to assemble
By one person



Recyclable
Aluminium frame



Collapsible aluminium frame

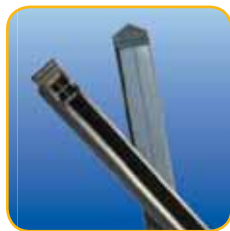

All magnetic bars and tape supplied



Complete with spotlights, cable and plug



Semi-rigid wheeled trolley/case included

Specification					
Size	Dimensions (w x h x d mm)	Option	Weight (kg)	Stock Status	Order Code
3 x 3	O/A: 2610 x 2320 x 660 Panel area: 3440 x 2300 Visual front: 2497 x 2300	Hardware kit	21	In stock	PUC3X3
		+ Printed panels*	27	Made to order	PUC3X3(P)
		+ Lamination*	29	Made to order	PUC3X3(PL)
4 x 3	O/A: 3120 x 2320 x 945 Panel area: 4140 x 2300 Visual front: 3196 x 2300	Hardware kit	26	In stock	PUC3X4
		+ Printed panels*	33	Made to order	PUC3X4(P)
		+ Lamination*	36	Made to order	PUC3X4(PL)

*Please allow a 3-5 working day turn around (subject to quantity).

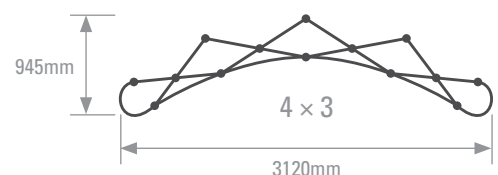
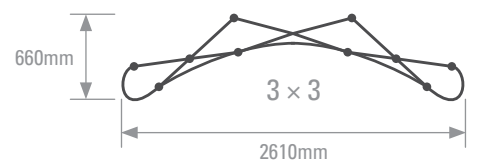

How to Assemble Curved Pop-Ups



Pull the frame up



Expand the frame



Frame fully erect



Insert magnetic bar at top



And slide in bar at bottom



Hook panels onto frame

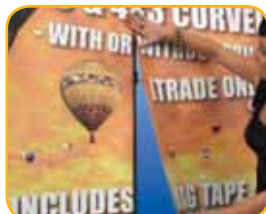

Press panels into place



Panel assembly complete



Plug lead into spotlights



Place onto front of frame



Slide bracket into place



Pop-Up complete with spotlights

Hard Trolley Case/Counter for Curved Pop-Ups

- Sturdy yet lightweight moulded **polyethylene case**
- Black laminated MDF counter top – simply unfolds and clips into place
- Built-in wheels for ease of movement
- Stores all Curved Pop-Up components with space for optional 'graphic wrap' (available separately)



In stock
Graphic wraps made to order



No tools assembly



2 minutes to assemble
Including graphic wrap



Recyclable
Polyethylene case and PVC 'graphic wrap'



Optional 'graphic wraps' feature magnetic strips for quick and easy installation



Shown with 3 x 3 Curved Pop-Up



Specification			
Item	O/A Dimensions (w x h x d mm)	Weight (kg)	Order Code
Case	593 x 890 x 400	10	MPUC
Counter top	700 x 8 x 500	3	MPUCTT
Graphic Wrap	1570 x 755	3	-
Fitting strips (for own graphic wrap production)	-	1	GWSTRIPS



X-Banner Stand

- Low cost, high impact banner display
- Simple fold-away design – no tools assembly
- Displays 600 × 1600mm eyeleted banners in a wide range of materials (available made to order)
- Banners simply hook into place – quick and easy to remove and replace
- Carbon fibre top poles provide excellent tension and stability, ensuring banners do not sag over time
- Black canvas carry bag included (extra durable carry case also available – see page 61)



In stock



1 minute to assemble



Recyclable

Steel legs and plastic mouldings

Specification			
Banner Size (mm)	O/A Dimensions (w × h × d mm)	Weight (kg)	Order Code
600 × 1600	655 × 1690 × 690	2	XBAN600



Adhesive top rail bonds to rear top edge of banner

Eco Roll-Up Banner

- Low cost, spring loaded 'roll-up' for single-sided banners
- Self-adhesive strips top and bottom for easy banner installation
- Silver anodised aluminium case, top rail, pole and folding feet
- Complete with black padded carry case and full instructions
- Now available for 800mm and 850mm wide banners



In stock



1 minute to assemble
+4 minutes if banner not pre-loaded



Recyclable

Aluminium case, top rail, pole and folding feet



All components fold away into portable carry bag (included)

Specification				
Banner Size (mm)	Display Area (mm)	O/A Dimensions (w × h × d mm)	Weight (kg)	Order Code
800 × 2000	800 × 1945	820 × 2050 × 365	3	ERBS8
850 × 2000	850 × 1945	870 × 2050 × 365	3.1	ERBS850

Banner Materials – We recommend smooth surface, lightweight rigid roll materials for Eco Roll-Up Banners, such as 125 micron grey backed polyester or 220 micron matt opaque PVC. Flexible, reinforced PVC banner materials have a textured surface and/or incorporate polymers which can react with adhesive tape so should be avoided. Do not use materials more than 300 micron thick.

Smart Roll Banner

Patent No. EP 05801071

High quality interchangeable banner displays

- Designed for a long, maintenance-free life
- Top and bottom aluminium 'clamp rails' and roller tension release mechanism make installing and removing banners quick and easy
- Banners simply roll into the case for storage and transit
- Telescopic pole allows banner height adjustment between 1 and 2.3m
- Single-sided units supplied with carry case (case for double-sided units available separately – see page 61 for details)



'Clamp rails' make installing and removing banners quick and easy



Recyclable
Aluminium case, clamp rails,
pole and folding feet

Single-Sided



In stock
900mm made to order



1 minute to assemble
+4 minutes if banner not pre-loaded

Double-Sided



Made to order



2 minutes to assemble
+6 minutes if banner not pre-loaded

Specification – Single-Sided					
Banner Width (mm)	Display Area (mm)	O/A Dimensions (w x h x d mm)	Weight (kg)	Stock Status	Order Code
800	800 x 1930	830 x 2340 (max) x 340	6.8	In stock	SRBS8
900	900 x 1930	930 x 2340 (max) x 340	7.5	Made to order	URBST00N92
1000	1000 x 1930	1030 x 2340 (max) x 340	8.5	In stock	SRBS10

Specification – Double-Sided					
Banner Width (mm)	Display Area (mm)	O/A Dimensions (w x h x d mm)	Weight (kg)	Stock Status	Order Code
800	800 x 1930	850 x 2340 (max) x 340	8.6	Made to order	URBSC00N82
900	900 x 1930	950 x 2340 (max) x 340	9.3		URBSC00N92
1000	1000 x 1930	1050 x 2340 (max) x 340	10		URBSC00N12

Banner Materials – A wide range of flexible or rigid media up to 300 micron thick can be used with Smart Roll Banners. For print quality, strength and dimensional stability, we recommend using 125-150 micron polyester based films with light block layer/backing or 220 micron opaque PVC – both in a matt white finish for optimum print results.

Quick Banner

Discreet, compact and lightweight banner display

- Top and bottom aluminium 'clamp rails' make installing and removing banners quick and easy
- Lightweight carry bag included with each unit
- Durable black carry cases also available separately (see page 61)
- Banner height (fixed): 2 metres
- Double-sided units feature adjustable pole for final tensioning
- Clip-on spotlights (50W) available separately (see page 61)



'Clamp rails' make installing and removing banners quick and easy



Recyclable
Aluminium clamp rails, pole and stand

Single-Sided



In stock
For 600 and 800mm wide banners



3 minutes to assemble

Double-Sided



Made to order



5 minutes to assemble

Specification – Single-Sided					
Banner Size (w × h mm)	Display Area (mm)	O/A Dimensions (w × h × d mm)	Weight (kg)	Stock Status	Order Code
600 × 2000	600 × 1980	603 × 2060 × 413	1.5	In stock	QBS62
700 × 2000	700 × 1980	703 × 2060 × 413	1.75	Made to order	UQBET00N72
800 × 2000	800 × 1980	803 × 2060 × 413	2	In stock	QBS82
900 × 2000	900 × 1980	903 × 2060 × 413	2.25	Made to order	UQBET00N92
1000 × 2000	1000 × 1980	1003 × 2060 × 413	2.5	Made to order	UQBET00N12

Specification – Double-Sided					
Banner Size (w × h mm)	Display Area (mm)	O/A Dimensions (w × h × d mm)	Weight (kg)	Stock Status	Order Code
600 × 2000	600 × 1970	606 × 2080 × 620	2.3	Made to order	UQB0C00N62
700 × 2000	700 × 1970	706 × 2080 × 620	2.7		UQB0C00N72
800 × 2000	800 × 1970	806 × 2080 × 620	3		UQB0C00N82
900 × 2000	900 × 1970	906 × 2080 × 620	3.4		UQB0C00N92
1000 × 2000	1000 × 1970	1006 × 2080 × 620	3.8		UQB0C00N12

Banner Materials – A wide range of flexible or rigid media up to 300 micron thick can be used with Quick Banners. For print quality, strength and dimensional stability, we recommend using 125-150 micron polyester based films with light block layer/backing or 220 micron opaque PVC – both in a matt white finish for optimum print results.

Adjustable Quick Banner

- Adjustable for banners between 1900 – 2200mm in height
- Weighted foot for improved stability
- Top and bottom aluminium 'clamp rails' make installing and removing banners quick and easy
- Lightweight carry bag included



Made to order



3 minutes to assemble



Recyclable
Aluminium clamp rails, pole and stand



Lightweight carry bag included



Specification				
Banner Width (mm)	Display Area (mm)	O/A Dimensions (w × h × d mm)	Weight (kg)	Order Code
600	600 × 2170 (max)	606 × 2240 (max) × 360	2.3	UQBAT01N62
700	700 × 2170 (max)	706 × 2240 (max) × 360	2.7	UQBAT01N72
800	800 × 2170 (max)	806 × 2240 (max) × 360	3.1	UQBAT01N82
900	900 × 2170 (max)	906 × 2240 (max) × 360	3.5	UQBAT01N92
1000	1000 × 2170 (max)	1006 × 2240 (max) × 360	3.8	UQBAT01N12

Banner Materials – A wide range of flexible or rigid media up to 300 micron thick can be used with Adjustable Quick Banners. For print quality, strength and dimensional stability, we recommend using 125-150 micron polyester based films with light block layer/backing or 220 micron opaque PVC – both in a matt white finish for optimum print results.

Promo Counters

- Portable flat-pack design – quick and easy to assemble
- Choice of Hexagonal or Convex with white laminate or wood tops
- Durable aluminium frames with silver anodised finish
- White foam PVC display panels
- Panels suitable for vinyl application or direct-to-surface print*
- Optional black carry bags available separately (see page 61)

*Due to possible curvature in convex panels, caution is required when printing direct-to-surface with flatbed digital printers



In stock
Convex with white top



10 minutes to assemble



Recyclable
Aluminium frames and foam PVC panels



Rear view of Hexagonal with wood top



Convex with white top



Hexagonal with white top

Specification						
Style	O/A Dimensions (w × h × d mm)	Panel Sizes (w × h mm)	Weight (kg)	Top	Stock Status	Order Code
Convex	1060 × 930 × 580	Front: 980 × 878 (×1) Sides: 430 × 878 (×2)	18.1	White	In stock	CONVXW
			20.2	Wood	Made to order	UPSM008000
Hexagonal	1225 × 930 × 550	Front: 659 × 878 (×1) Sides: 311 × 878 (×4)	19.3	White	Made to order	UPSM001000
			21.3	Wood		UPSM007000

Promo Stands

Lightweight, portable and cost-effective display counters, now available in 2 stock sizes

- Flat-pack design for easy storage and transit
- Moulded white HIPS counter top, base and shelf
- White powder coated steel poles
- White foam PVC header and polypropylene counter panel – ideal for printed vinyl application
- Both sizes supplied complete with carry bag



Petite

Maximum Loads
Counter top: 20kg
Internal shelf: 10kg

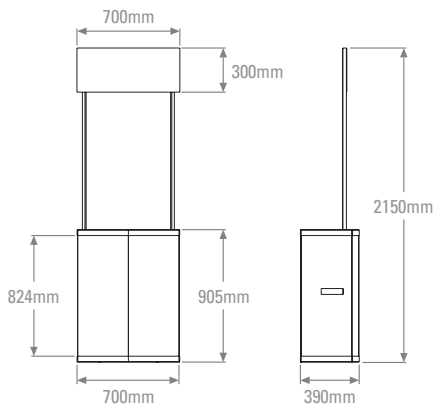

Specification – Petite					
Panel	Panel Size (mm)	Display Area (mm)	O/A Dimensions (w x h x d mm)	Weight (kg)	Order Code
Header	700 x 300	700 x 300	700 x 2150 x 390	12.8	PETITPROMO
Counter	1596 x 900	1584 x 824*			

*Individual panel display areas – Front: 352 x 824 (x2). Sides: 340 x 824 (x2).



Large

Maximum Loads
Counter top: 25kg
Internal shelf: 20kg

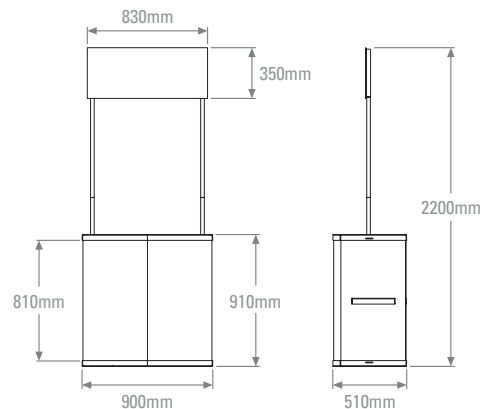

Specification – Large					
Panel	Panel Size (mm)	Display Area (mm)	O/A Dimensions (w x h x d mm)	Weight (kg)	Order Code
Header	830 x 350	830 x 350	900 x 2200 x 510	14.1	PROMSTDWB
Counter	2004 x 900	1976 x 810*			

*Individual panel display areas – Front: 441 x 810 (x2). Sides: 423 x 810 (x2).



In stock



10 minutes to assemble



Recyclable

Steel poles, moulded HIPS base, shelf and counter top, polypropylene counter panel and foam PVC header

Accessories

for Portable Exhibition Displays

Carry Cases

for X-Banner Stand & Quick Banners

- Black canvas carry bag with rigid tube liner
- Stores complete hardware and banner(s)

Specification			
Banner Width (mm)	Suitable Items	Weight (kg)	Order Code
Up to 800	Quick Banners only	1.4	BCB8
Up to 1000	Quick Banners & X-Banner	1.6	BCB10



In stock



Carry Cases for Double-Sided Smart Roll Banners

- Black padded canvas bag
- Stores complete hardware and banners

Specification	
Banner Width (mm)	Order Code
800	UYUP070000
Up to 1000	UYUP071000



Made to order



Spotlight for Quick Banners

- 50 watts power output
- Clips quickly and easily into place
- CE/UL Pat tested



Order Code
UQB1001000



Made to order

Carry Bag for Promo Counters

- Black textile bag
- Stores complete hardware

Specification		
Counter Type	Stock Status	Order Code
Convex	In stock	CONVXBG
Hexagonal	Made to order	UYUP074100



In stock
(Convex)



Flange Signs

Low cost, high impact flat projecting signs, available in 3 standard shapes



In stock



Recyclable
Aluminium panels



Round



Oval



Rectangular

Available screen/digitally printed (minimum order quantity: 25)

- Cost-effective, double-sided shop front advertising
- Exceptional value – 5+ years outdoor life
- 2mm aluminium panels with gloss white polyester powder coated finish – ideal for vinyl application
- 50mm fixing flange, pre-drilled with round fixing holes as standard

Specification				
Shape	O/A Dimensions (w x h x d mm)	Display Area (w x h mm)	Weight (kg)	Order Code
Round	556 x 495 x 50	495 diameter	1.8	FLSR
Oval	605 x 400 x 50	500 x 400	1.6	FLSO
Rectangular	582 x 417 x 50	575 x 417	1.8	FLSS

Custom Shaped Flange Signs

Endless possibilities through different shapes and sizes



Made to order
Minimum order quantity: 25



3D Projecting Signs

- 3-dimensional alternative to Flange Signs, for even greater impact
- Vibrant screen printed graphics
- Extremely cost-effective on high volumes (one-off tooling charge applies)
- Injection moulded 3D elements supported on a **steel/aluminium bracket/frame**



Made to order
Minimum order quantity: 500
(subject to sight of design)



Recyclable
ASA/polyethylene mouldings and
steel/aluminium bracket/frame



Projecting Lightboxes



Standard Design	1 Domed Oval	2 Domed Oval	3 Domed Oval	4 Round Dome
Dimensions (mm)	583 x 746	700 x 290	590 x 436	500mm diameter

- Round-the-clock shop front advertising
- Vacuum formed **PETG panels** on a powder coated **steel frame/bracket**
- Designed to strict safety standards
- Individually boxed and ready for installation
- 4 standard (pre-tooled) designs available
- Custom design service available (minimum order quantity: 200)



Made to order
Minimum order quantity: 50



Recyclable
PETG panels and steel frame/bracket

Noscrewz Flag Kit

Patent No. GB 2443417

Ideal for glass mounting



With printed Display Flag

- Safe, tamper-proof and secure on any flat, smooth surface
- Incredibly quick and easy to use – simply push onto glass and twist, no tools required!
- Kits include **bracket**, sectional **pole**, **collar** and **finial**
- Suitable for internal and external use
- Plain **PVC flags** in stock (see page 66 for details), available printed to order



In stock



No tools assembly



Recyclable

PVC/ASA bracket, PVC pole, polypropylene collar and finial, and reinforced PVC flag

How does Noscrewz work?

A simple twist creates a vacuum that locks the bracket in place.

Simply twist back and pull upper or lower tab to release bracket.



Simply twist bracket onto the glass



Pull tab to release

Sectional pole included with each kit

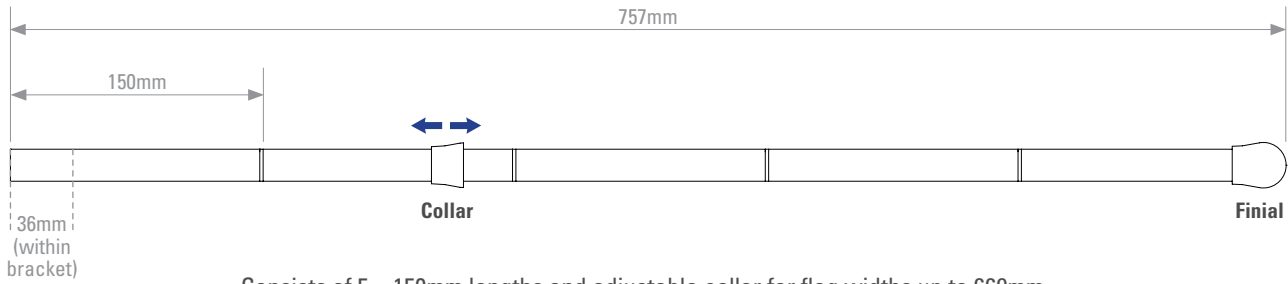

Consists of 5 × 150mm lengths and adjustable collar for flag widths up to 669mm

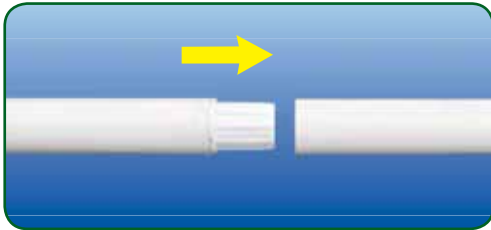

Simply push in and pull out pole sections to change length

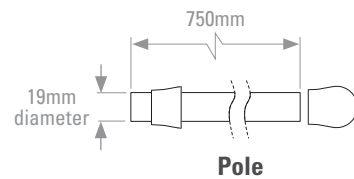
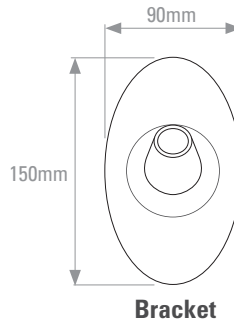

Specification				
Kit Contents	Part Dimensions (mm)	Colour	Weight (kg)	Order Code
Noscrewz flag bracket, pole, finial and collar	Bracket: 90 (w) × 150 (h) Pole length: 150/300/450/600/750 Pole diameter: 19	White	0.4	NOSCREWZ2

Noscrewz can be used in many different ways, with custom shaped flags available made to order



Made to order

Minimum order quantity (guide): 25
(due to one-off cutter charge)





With printed Display Flag



Bracket

Standard Flag Kit

For wall mounting

- Tapered socket ensures excellent pole grip and prevents loss of flags in windy conditions
- Suitable for screw fixing to walls
- Kit includes **polypropylene bracket**, PVC pole, finial and collar
- Plain **PVC flags** in stock (see below for details), available printed to order
- Custom shaped flags also available (see page 65 for details)



In stock



Recyclable
Polypropylene bracket



PVC pole, collar and finial

Specification		
Dimensions (mm)	Weight (kg)	Order Code
Bracket: 50 (w) x 117 (h) Pole: 750 (length) x 19 (dia.)	0.2	FLKIT



With Noscrewz Flag Kit

Display Flag

For Noscrewz and Standard Flag Kits

- Plain white flags held in stock – ideal for vinyl application
- Available screen/digitally printed to order
- High performance reinforced **light block PVC** (750gsm) with fully stitched sleeve for maximum outdoor life



In stock



Recyclable
Reinforced PVC flag

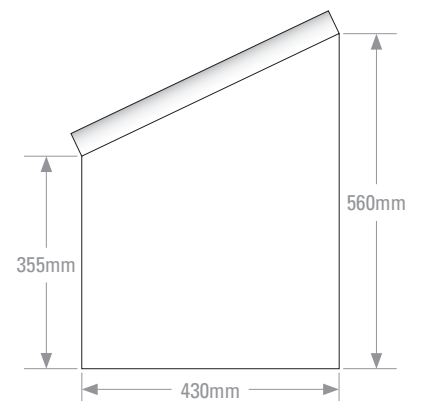

Order Code
FLAGTRADE

Giant Pole

Huge attention grabbing outdoor display

- High impact display for 1.1 × 4.1m textile flag
- Ideal for forecourts, shopping malls, exhibitions and events
- 2-part water-fillable **polyethylene base** for optimum stability (carry bag included)
- Telescopic **aluminium pole** with silver anodised finish (54mm diameter at base)
- Printed flags available to order (single and double-sided)



In stock
Printed flags made to order



6 minutes to assemble



Recyclable
Aluminium pole and polyethylene base



360° rotating flag arm



Telescopic pole

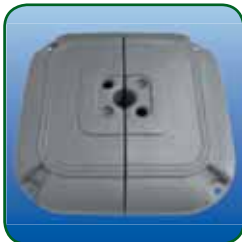

2-part folding base for ease of transportation



Water-fillable base with clip-in leg fixings



Flags

Our standard flag material is a 115gsm close weave knitted polyester textile, chosen for its **durability** and **image vibrancy**. For optimum **performance**, a 135gsm 'airmesh' material is also available which, thanks to small holes in the fabric, presents **less resistance** in the wind.

All flags are printed by 'dye-sublimation' which uses special inks and undergoes a post-print heating process to 'fix' the ink into the fabric, making it **scuff resistant** and **washable** and **maximising show-through** on the reverse.

Double-Sided Flags

A twin layer of standard polyester fabric with central liner allows different designs on each side and a good level of opacity. Due to the added weight, double-sided flags will not flutter in the wind in the same way as standard flags.

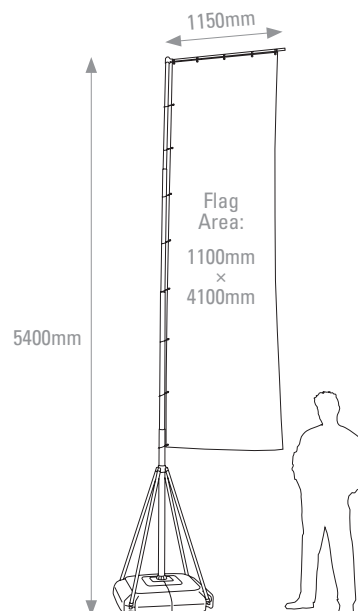

Specification				
Item	O/A Dimensions (w × h × d mm)	Weight (kg) Empty/Full	Stock Status	Order Code
Giant Pole hardware (exc. Flag)	Base: 800 × 180 × 800 O/A height: 5.4m	15/70	In stock	GIANTPOLE
Printed Flag	1100 × 4100	–	Made to order	GIANTBANNER

Flying Banners



In stock
Printed flags made to order



No tools assembly



Feather – flutters and rotates in the wind



Teardrop – rotates in the wind

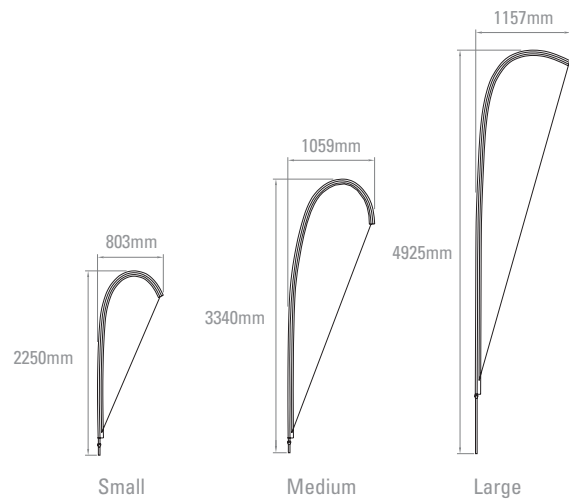
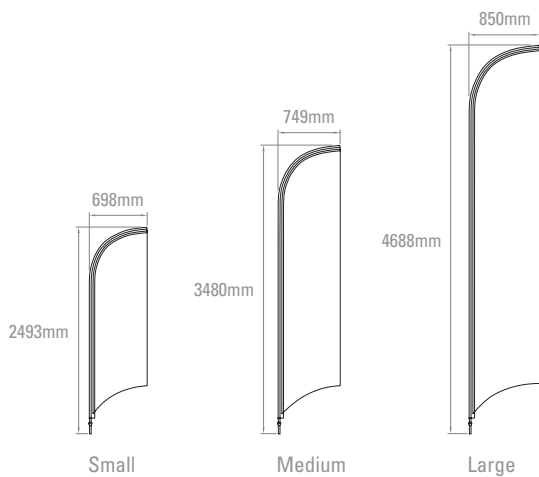

- Suitable for interior and exterior use
- High performance carbon fibre poles
- Lightweight, portable and easy to assemble
- Available in 3 stock sizes with 'Feather' or 'Teardrop' flags
- Printed flags available to order
- Choice of mounting accessories available (see following page)



Black canvas bag supplied with each pole includes compartments to store flag, ground spike and water bag

Flags

Our standard flag material is a 115gsm close weave knitted polyester textile, chosen for its **durability and image vibrancy**. For optimum **performance**, a 135gsm 'airmesh' material is also available which, thanks to small holes in the fabric, presents **less resistance** in the wind.

All flags are printed by 'dye-sublimation' which uses special inks and undergoes a post-print heating process to 'fix' the ink into the fabric, making it **scuff resistant** and **washable** and **maximising show-through** on the reverse.

Flag templates are available on request for your own flag production

Specification						
Size	Flag Shape	O/A Height (mm)	Flag Size (mm)	Pole & Bag Weight (kg)	Order Code	
					Pole & Bag	Flag
Small	Feather	2493	698 x 2253	1	FBF20	FBF24B
	Teardrop	2250	803 x 1990		FBT19	FBT22B
Medium	Feather	3480	749 x 3190	1.5	FBF29	FBF35B
	Teardrop	3340	1059 x 3060		FBT30	FBT35B
Large	Feather	4688	850 x 4348	2	FBF40	FBF48B
	Teardrop	4925	1157 x 4050		FBT39	FBT48B



Flags feature adjustable draw string tethers to ensure best appearance

Mounting Accessories for Flying Banners



In stock



No tools assembly

Cross Base & Water Bag

- Ideal for use on hard standing ground, indoors or out
- Powder coated **steel cross base**, with ball bearing central pivot for friction-free flag rotation
- Male pole connections with 'O' rings provide a perfect and secure fit
- Holes at end of feet allow for pegging to soft ground (pegs not included)
- Optional water-fillable water bag, for added stability



Specification			
Item	Dimensions (mm)	Weight (kg)	Order Code
Cross Base	Length: 840 Width: 60	4	FBBASE(2)
Water Bag	540 diameter	Empty: 0.6 / Full: 7.2	FBBAG(H)



Recyclable
Steel cross base

Ground Spike

- Chrome plated **steel spike** for soft ground, sand or snow
- Bearing spindle for smooth flag rotation
- Male pole connections with 'O' rings provide a perfect and secure fit as well as offering free rotation to deflect wind loading

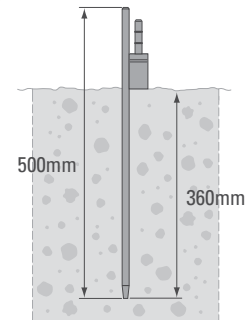

Specification	
Weight (kg)	Order Code
1.2	FBSPIKE(2)



Recyclable
Steel ground spike

Wheel Base

- Black powder coated **steel feet** with chrome plated **steel bearing spindle**
- Quick and easy to assemble without tools
- Simply wedge under car wheel or drive onto base for maximum security
- Folding design for ease of storage and transit



The wheel base is suitable for small and medium Flying Banners using the relevant pole/conversion kit listed below, which prevents the flag making contact with vehicle bodywork.

Kit 1 – for a small feather/teardrop flag on a medium pole

Kit 2 – for a medium feather flag on a large pole

Kit 3 – for a medium teardrop flag on a large pole

Specification		
Item	Weight (kg)	Order Code
Wheel Base	4	FBWHEEL(2)
Conversion Kit 1	–	FBCONVSFMP
Conversion Kit 2	–	FBFFCONVMFLP
Conversion Kit 3	–	FBTFCONVMFLP



Recyclable
Steel feet and spindle

D-Light

- Attractive convex lightbox for a range of poster sizes
- Single-sided display for internal wall mounting
- **Aluminium snapframe sides** for quick and easy poster change
- Silver anodised **aluminium case** with 3mm opal **acrylic diffuser panel**
- Tube lighting (single or double depending on size)
- Key holes to rear for ease of installation
- Anti-glare **PET poster cover** ensures clarity of message
- Supplied complete with 2m cable and plug
- CE certificate supplied with each unit
- Also available in custom sizes and colours made to order (minimum recommended quantity: 5)



In stock

Certain sizes made to order (see below)



No assembly required



Recyclable

Aluminium snapframe sides, aluminium case, acrylic diffuser panel and PET poster cover



Snapframe sides for quick and easy poster change. Image shows cable entry and 'pepperpot' ventilation cover to underside.



Opal acrylic lens panel can be removed for tube replacement



Custom sizes available (minimum order quantities apply)

Specification						
Poster Size	Display Area (w × h mm)	O/A Dimensions (w × h × d mm)	Lighting	Weight (kg)	Stock Status	Order Code
A3	273 × 420	308 × 423 × 82	1 × 8W	3.1	In stock	DLIGHTA3
A2	395 × 594	424 × 597 × 98	1 × 15W	5.8		DLIGHTA2
A1	570 × 841	592 × 844 × 120	2 × 18W	11		DLIGHTA1
A0	816 × 1189	828 × 1192 × 150	2 × 30W	18.3	Made to order	UCLB250NA0
20" × 30"	484 × 762	510 × 765 × 108	1 × 18W	8		UCLB250N23
30" × 40"	737 × 1016	750 × 1019 × 143	2 × 30W	14.9		UCLB250N34
500 × 700mm	475 × 700	500 × 703 × 110	1 × 18W	7.8		UCLB250NB2
700 × 1000mm	675 × 1000	692 × 1003 × 134	2 × 30W	13.8		UCLB250NB1

Edgelit XT

Our new 'extra thin'
LED snapframe



- Specially treated **acrylic panel** provides strong, even illumination across the entire surface
- Front-opening **aluminium snapframes** for quick and easy poster change (silver anodised 25mm profile)
- Anti-glare **PET poster covers** ensure clarity of message
- Slim, elegant design – single-sided units only 19mm deep
- No fragile tubes, bulbs or glass – ideal for busy, high-traffic locations
- 3m extension cables (available separately) enable flexible positioning
- CE certificate supplied with each unit
- Also available in custom sizes and colours made to order (minimum recommended quantity: 5)



In stock
Single-sided A2, A1, A0 and 30" x 40"



No assembly required



Recyclable
Aluminium snapframes, PET poster covers and acrylic panels



LED illumination...

- Bright, even and long-lasting – 50,000+ hours life!
- Low-voltage – low power consumption and completely safe
- No need for qualified electrician to install
- No risk of bulb breakages – maintenance free



Front-opening snapframes for quick and easy poster change



Built-in on/off switch



Anti-glare PET poster covers

Specification – Single-Sided

Poster Size	Display Area (mm)	O/A Dimensions (w × h × d mm)	Weight (kg)	Stock Status	Order Code
A4	190 × 277	242 × 329 × 19	2.6	Made to order	ULD25TN0A4
A3	277 × 400	329 × 452 × 19	3.4	Made to order	ULD25TN0A3
A2	400 × 574	452 × 626 × 19	4.2	In stock	LEDA2
A1	574 × 821	626 × 873 × 19	8.1	In stock	LEDA1
A0	821 × 1169	873 × 1221 × 19	13.5	In stock	LEDA0
20" × 30"	488 × 742	540 × 794 × 19	6.7	Made to order	ULD25TN023
30" × 40"	742 × 996	794 × 1048 × 19	10.8	In stock	LED34
500 × 700mm	480 × 680	532 × 732 × 19	6.4	Made to order	ULD25TN0B2
700 × 1000mm	680 × 980	732 × 1032 × 19	9.9	Made to order	ULD25TN0B1

Specification – Double-Sided

Poster Size	Display Area (mm)	O/A Dimensions (w × h × d mm)	Weight (kg)	Stock Status	Order Code
A4	190 × 277	242 × 329 × 28	3.1	Made to order	ULD25CN0A4
A3	277 × 400	329 × 452 × 28	4		ULD25CN0A3
A2	400 × 574	452 × 626 × 28	5.8		ULD25CN0A2
A1	574 × 821	626 × 873 × 28	10		ULD25CN0A1
20" × 30"	488 × 742	540 × 794 × 28	8.4		ULD25CN023
30" × 40"	742 × 996	794 × 1048 × 28	14.4		ULD25CN034
500 × 700mm	480 × 680	532 × 732 × 28	8		ULD25CN0B2
700 × 1000mm	680 × 980	732 × 1032 × 28	13.2		ULD25CN0B1

Snaplight

- Front-opening aluminium snapframes for quick and easy poster change
- 25mm snapframe profile with silver anodised finish
- Back lit system provides strong, even illumination
- Anti-glare PET poster covers ensure clarity of message
- Opal acrylic diffuser panel – removable for installation and tube replacement
- Galvanised steel backing (single-sided)
- Available in a range of sizes, single and double-sided
- Suitable for posters or transparencies
- CE certificate supplied with each unit
- Also available in custom sizes and colours made to order (minimum recommended quantity: 5)



Made to order



No assembly required



Recyclable

Aluminium snapframes, PET poster covers and acrylic diffuser panels



Front-opening snapframes



Anti-glare PET poster covers



Double-sided option with hangers

Specification – Single-Sided

Poster Size	Display Area (mm)	O/A Dimensions (mm)	Weight (kg)	Lighting	Order Code
A3	275 × 389	327 × 450 × 100	3.2	1 × 32W	ULBT250NA3
A2	389 × 572	450 × 624 × 100	6.4	2 × 15W	ULBT250NA2
A1	572 × 819	624 × 871 × 100	11.8	5 × 15W	ULBT250NA1
A0	819 × 1167	871 × 1219 × 100	17.7	4 × 30W	ULBT250NA0
20" × 30"	486 × 740	538 × 792 × 100	8.5	2 × 18W	ULBT250N23
30" × 40"	740 × 994	792 × 1046 × 100	15	4 × 30W	ULBT250N34
40" × 60"	994 × 1502	1046 × 1554 × 100	25	5 × 58W	ULBT250N46
500 × 700mm	478 × 678	530 × 730 × 100	8.1	2 × 18W	ULBT250NB2
700 × 1000mm	678 × 978	730 × 1030 × 100	13.4	3 × 30W	ULBT250NB1

Specification – Double-Sided

Poster Size	Display Area (mm)	O/A Dimensions (mm)	Weight (kg)	Lighting	Order Code
A3	275 × 389	327 × 450 × 110	3.4	1 × 32W	ULBC250NA3
A2	389 × 572	450 × 624 × 110	7.2	2 × 15W	ULBC250NA2
A1	572 × 819	624 × 871 × 110	12.8	5 × 15W	ULBC250NA1
A0	819 × 1167	871 × 1219 × 110	21	4 × 30W	ULBC250NA0
20" × 30"	486 × 740	538 × 792 × 110	8.9	2 × 18W	ULBC250N23
30" × 40"	740 × 994	792 × 1046 × 110	16.9	4 × 30W	ULBC250N34
40" × 60"	994 × 1502	1046 × 1554 × 110	27	5 × 58W	ULBC250N46
500 × 700mm	478 × 678	530 × 730 × 110	8.1	2 × 18W	ULBC250NB2
700 × 1000mm	678 × 978	730 × 1030 × 110	16	3 × 30W	ULBC250NB1

Illuminated Totem

- Double-sided freestanding poster display for internal use
- Elegant convex design
- Front-opening **snapframe sides** for quick and easy poster change
- Silver anodised **aluminium casing** with silver coated **steel base**
- Anti-glare **PET poster covers** (permanently fixed on one side with magnetic seal on the other)
- Fluorescent tube lighting (single or double depending on size)
- Supplied complete with 2m cable and plug
- CE certificate supplied with each unit



Made to order



20 minutes to assemble



Recyclable

Aluminium casing/snapframe sides, steel base, PET poster covers and acrylic diffuser

Specification				
Poster Size (w x h mm)	O/A Dimensions (w x h x d mm)	Weight (kg)	Lighting	Order Code
600 x 1700	650 x 1720 x 350	28	1 x 58W	UTTM001000
700 x 1700	750 x 1720 x 350	30.8	1 x 58W	UTTM002000
800 x 1700	850 x 1720 x 370	36.5	2 x 58W	UTTM003000



Decorative Totem

- Double-sided freestanding poster display for internal use
- Elegant convex design
- Front-opening **snapframe sides** for quick and easy poster change (top half only)
- Embossed metal effect **polystyrene panels** at bottom with silver coated **steel base**
- Anti-glare **PET poster covers** (permanently fixed on one side with magnetic seal on the other)
- Fluorescent tube lighting (single or double depending on size)
- Supplied complete with 2m cable and plug
- CE certificate supplied with each unit



Made to order



20 minutes to assemble



Recyclable

Aluminium casing/snapframe sides, polystyrene panels, steel base, PET poster covers and acrylic diffuser

Specification				
Poster Size	O/A Dimensions (w x h x d mm)	Weight (kg)	Lighting	Order Code
A1	650 x 1720 x 350	30	1 x 18W	UTTM011010
A0	880 x 1720 x 370	36	2 x 36W	UTTM011030
500 x 700mm	560 x 1720 x 350	26	1 x 18W	UTTM011040
700 x 1000mm	750 x 1720 x 350	32	1 x 30W	UTTM011020



Freelight Plus

The most cost-effective lightbox on the market

EU Design Registration No. 000433131

- Uses existing in-store lighting for illumination
- Flat-pack design – easy to assemble and install
- Graphic inserts quick and easy to update



Each kit includes:

- Outer lens panel
- Opal 'lampshade' PVC insert – ideal for translucent vinyl or screen/digitally printed graphics
- Pair of end caps
- Ceiling hooks and eyelets



Each kit includes ceiling hooks and 2 styles of 'button' eyelets



Coloured and/or pad printed end caps available (minimum order quantity: 500)



Existing Lighting

Suspended ceilings offer prime advertising space and, with existing lighting, are perfect for Freelight Plus



Freelight Plus

With no need for wires or power, Freelight Plus is quick to assemble and simply hooks into place using the fixing kit supplied



High impact, low cost advertising

Most of the benefits of a traditional lightbox, but without the cost and inconvenience!

Freelight Plus offers unbeatable long-term return on investment – simply change the insert for new promotions or leave in for permanent display



Specification		
O/A Dimensions (w x h x d mm)	Weight (kg)	Order Code
648 x 256 x 226	1.3	FREELIGHTUNB



In stock



3 minutes to assemble



No tools assembly



Recyclable
ABS end caps and polypropylene outer lens panel

Halo Lightbox

- Permanently branded lightbox for interior wall mounting
- Stunning 'halo' effect
- 3 standard shapes available
- Supplied complete with cable and plug
- CE approved



Made to order
Minimum order quantity: 100



Recyclable
Steel and PETG

Specification	
Shape	Size (mm)
Oval 1	585 × 432
Oval 2	695 × 290
Round	500 (diameter)

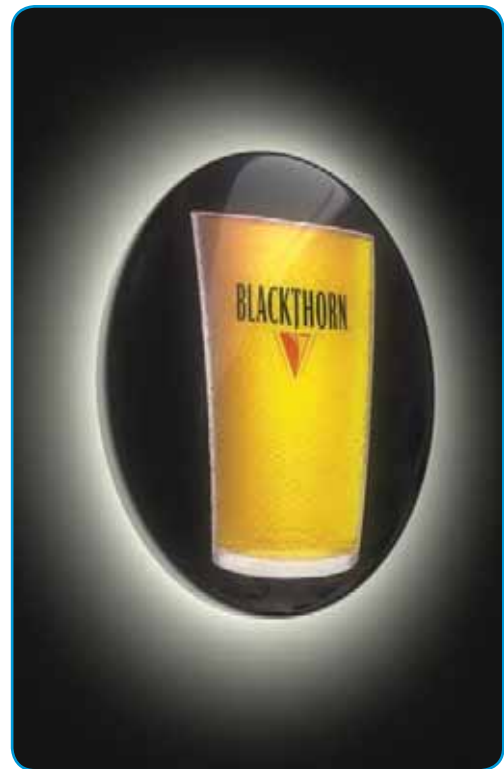

Illuminated Info Board

- High impact poster display
- Front-opening aluminium snapframes for quick and easy poster change
- Silver anodised finish with anti-glare PET poster covers
- Single and double-sided versions available
- Optional brochure shelves available (see page 42 for details)
- CE certificate supplied with each unit



Made to order



10 minutes to assemble



Recyclable
Aluminium snapframes, aluminium stand,
PET poster covers and acrylic diffuser panel



Optional wheels



Anti-glare
PET poster covers

Specification				
Poster Size	O/A Dimensions (w × h × d mm)	Type	Weight (kg)	Order Code
A1	740 × 1760 × 450	Single-sided	17.5	UIB305TNA1
		Double-sided	17.9	UIB305CNA1
500 × 700mm	646 × 1760 × 450	Single-sided	15	UIB305TNB2
		Double-sided	15.4	UIB305CNB2
700 × 1000mm	853 × 1760 × 450	Single-sided	20.5	UIB305TNB1
		Double-sided	20.9	UIB305CNB1



Clear Leaflet Dispensers

Crystal clear injection moulded styrene leaflet holders in a wide range of stock sizes

- Great prices on mass produced lines – 1/3 A4, A5 and A4 single compartment dispensers
- Colours and branding available on volume orders (minimum order quantities apply – see below)
- Business card holders and other non-stock sizes available – please call for details



In stock



No assembly required



Recyclable
High impact polystyrene (HIPS) leaflet dispensers



Specification – Single Compartment

Description	1/3 A4 freestanding	A5 freestanding	A4 freestanding	1/3 A4 wall mounted	A5 wall mounted	A4 wall mounted
Opening Size (mm)	109 × 32	160 × 32	220 × 32	110 × 32	159 × 32	222 × 32
O/A Dimensions (mm)	111 × 198 × 83	162 × 198 × 83	222 × 291 × 96	112 × 165 × 40	161 × 165 × 40	224 × 249 × 40
Order Code	BHC110	BHC160	BHC230	BHW110	BHW160	BHW230

Single compartment leaflet dispensers available printed (minimum order quantity: 200).



Specification – Multi Compartment

Description	2 × 1/3 A4 side-by-side freestanding	2 × 1/3 A4 stacked freestanding	4 × 1/3 A4 stacked freestanding	4 × A4 stacked freestanding or wall*	4 × compartment A4 landscape stacked**
Opening Size (mm)	112 × 32 (×2)	110 × 42 (×2)	110 × 32 (×2)	230 × 32 (×4)	336 × 32 (×4)
O/A Dimensions (mm)	233 × 249 × 85	115 × 270 × 120	115 × 255 × 150	236 × 340 × 175	340 × 345 × 175
Order Code	BH2C112	BH2C110	BH4C110	BH4C230	BH4C330

Multi-compartment leaflet dispensers available printed (minimum order quantity: 100).

*Includes dividers for 8 × 1/3 A4 compartment option

**Includes dividers for a combination of compartment sizes, freestanding or wall mounted

Decorative Brochure Stand

- A4 brochure display plinth, available in portrait or landscape
- Clear 3mm polycarbonate display shelf for optimum strength (depth: 100mm)
- Silver anodised aluminium leg (50 × 25mm oval)
- Moulded silver plastic base with hidden steel plate for stability



In stock



6 minutes to assemble



Recyclable

Polycarbonate shelf, aluminium leg, high impact polystyrene (HIPS) base and steel base plate



Display shelf fixes easily onto stand with screws (supplied)



Base/leg assembly using Allen key (supplied)



Landscape

Portrait

Specification				
Poster Size	Format	O/A Dimensions (w × h × d mm)	Weight (kg)	Order Code
A4	Landscape	250 × 970 × 330	3.5	DBSA4L
	Portrait	250 × 1000 × 330		DBSA4P

Zig-Zag Brochure Stand

- 6 × A4 capacity with updateable convex header
- Eye-catching brochure display with small footprint
- 51 × 25mm flat oval aluminium legs and 10mm acrylic display shelves
- Moulded silver plastic base with hidden steel plate for stability
- Shelf dimensions: 220mm (w) × 42mm (d)



Made to order



15 minutes to assemble



Recyclable

Aluminium legs, acrylic shelves, high impact polystyrene (HIPS) base and steel base plate



Double-sided snapframe header – quick and easy to update



218 × 165mm header insert protected behind cover sheet

Specification		
O/A Dimensions (w × h × d mm)	Weight (kg)	Order Code
300 × 1785 × 420	13.4	UZZCAC1002



Brochure Island Stands

A range of stylish 'walk-around' brochure display units



Diamond

With 10 x A4 brochure holders

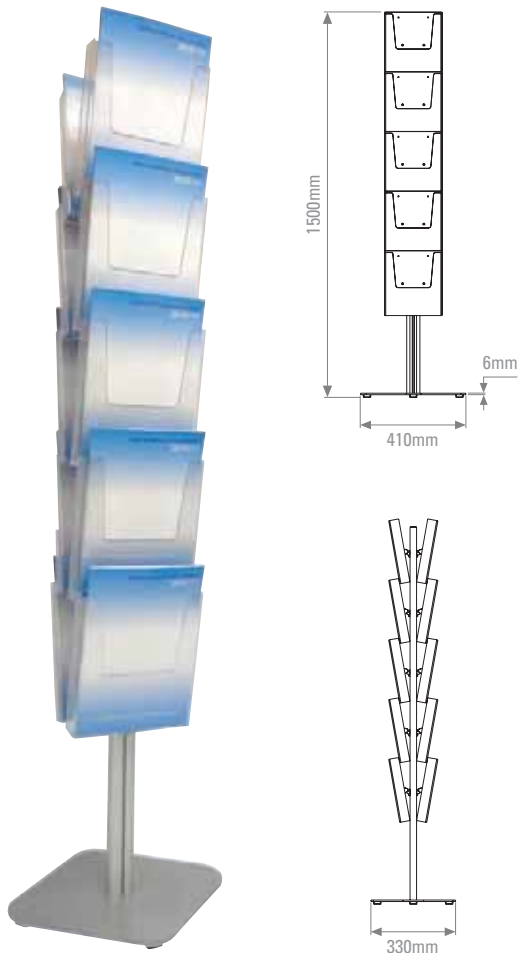

In stock



6 minutes to assemble



Specification			
Capacity	O/A Dimensions (w x h x d mm)	Weight (kg)	Order Code
10 x A4	410 x 1500 x 330	11	MULTISIDEBODY(1)

Hexagonal

With 15 x A4 brochure holders

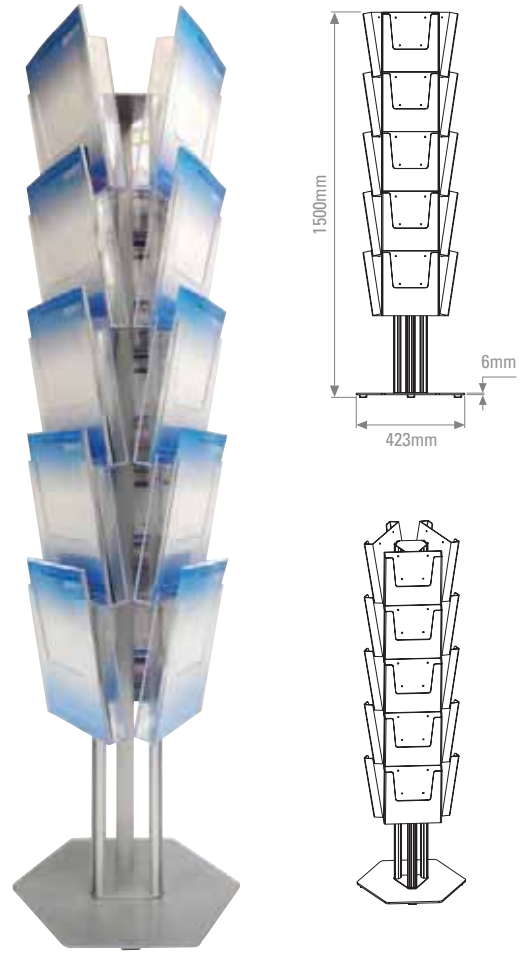

In stock



8 minutes to assemble



Specification			
Capacity	O/A Dimensions (w x h x d mm)	Weight (kg)	Order Code
15 x A4	423 x 1500 x 370	16.2	MULTISIDEBODY(3)

- Quick and easy to assemble with clip-fit polystyrene brochure holders
- Silver anodised aluminium frames
- Weighted steel bases for optimum stability
- Brochure holder internal depth: 35mm



Recyclable
Aluminium frames, high impact polystyrene (HIPS) brochure holders and steel bases

Small Oval

With 16 x A4 brochure holders

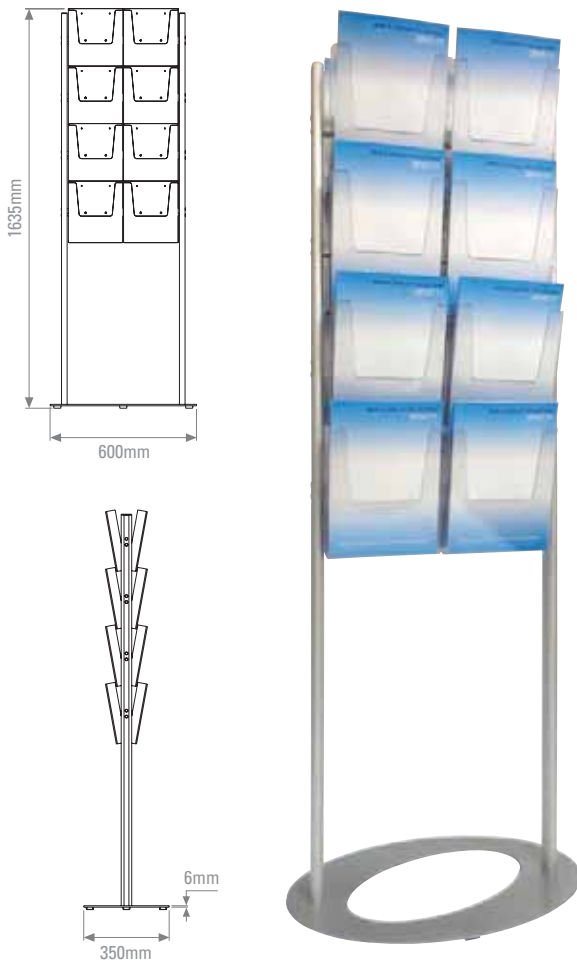

Made to order



8 minutes to assemble



Specification			
Capacity	O/A Dimensions (w x h x d mm)	Weight (kg)	Order Code
16 x A4	600 x 1635 x 350	16.3	UCBSG00024

Large Oval

With 24 x A4 brochure holders

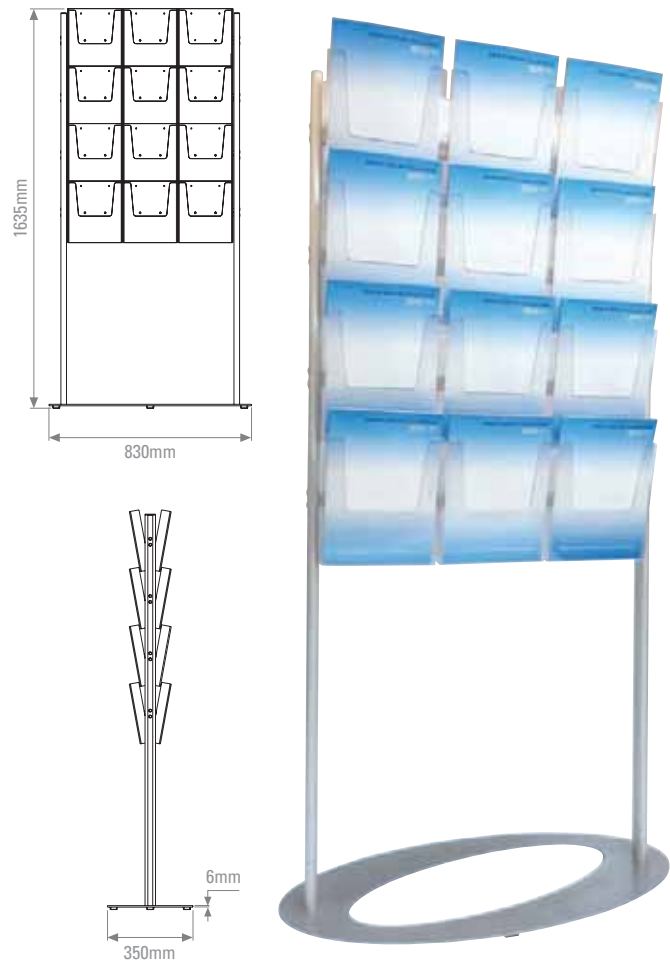

Made to order



10 minutes to assemble



Specification			
Capacity	O/A Dimensions (w x h x d mm)	Weight (kg)	Order Code
24 x A4	830 x 1635 x 350	22.4	UCBSG00034



Double-sided freestanding display with optional wheels (32 x A4)

Brochure Display Units

- Simple and stylish designs for between 8 and 32 A4 brochures
- Silver anodised aluminium frames (50 x 25mm) with acrylic brochure shelves
- Single and double-sided freestanding units available with optional wheels
- Shelf internal capacity: 40mm (d)



Double-sided freestanding display (16 x A4)



Single-sided display for wall mounting (8 x A4)



Made to order
Single-sided for wall mounting held in stock



Recyclable
Aluminium frames and acrylic shelves

Specification

Single/Double-Sided	Capacity	O/A Dimensions (w x h x d mm)	Weight (kg)	Stock Status	Order Code
Single (freestanding)	8 (4 x 2) x A4	546 x 1760 x 450	12.5	Made to order	UBSST10N24
	12 (4 x 3) x A4	766 x 1760 x 450	15.9		UBSST10N34
	16 (4 x 4) x A4	986 x 1760 x 450	19.4		UBSST10N44
Single for wall	8 (4 x 2) x A4	520 x 1450 x 240	13	In stock	BRCHSETWALL
Double (freestanding)	16 (4 x 2) x A4	546 x 1760 x 450	15.7	Made to order	UBSSC10N24/UYSR
	24 (4 x 3) x A4	766 x 1760 x 450	20.2		UBSSC10N34/UYSR
	32 (4 x 4) x A4	986 x 1760 x 450	25.7		UBSSC10N44/UYSR



Clear Menu Holders

- For single or double-sided paper inserts (1/3 A4, A5 or A4)
- Menu sleeve simply push fits into base
- Bases also available printed (minimum order quantity: 100)



In stock



Recyclable
PET sleeves and styrene bases

Specification

Size	O/A Dimensions (w x h x d mm)	Weight (kg)	Order Code
1/3 A4 (DL)	100 x 220 x 50	0.7	BHV100B BHV100MH
A5	152 x 238 x 63	1.3	BHV150B BHV150MH
A4	212 x 330 x 86	2.3	BHV210B BHV210MH



Custom menu holders available in a range of materials, shapes and sizes



Made to order
Minimum order quantity: 50

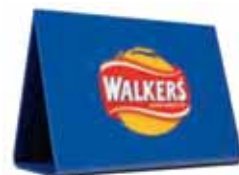

GripTalkers



Available in 3 stock sizes, these simple yet stylish menu holders feature our spring-powered 'grip-action' bases

PET Sleeves

- For double-sided paper inserts
- Semi-rigid, unbreakable PET – avoids brittle cracks so often seen with acrylic
- Available in 1/3 A4, A5 and A4 stock sizes

Bases

- Aluminium with silver anodised finish as standard
- Spring-powered 'grip-action' – simply open by hand, insert sleeve and release
- Suitable for self-adhesive vinyl, 'polydome stickers' or pad-printed graphics*
- Available in custom sizes, colours and finishes made to order (minimum order quantity: 100)

*Maximum pad-print height: 15mm

Other Display Options

These bases are suitable for almost any rigid sheet material between 1-4mm thick. E.g. acrylic, PVC, PET, foam PVC and HPL chalkboard panels (see page 44).

Printed panels available made to order (minimum order quantity: 25).



In stock



No tools assembly



Recyclable

Aluminium bases and PET sleeves

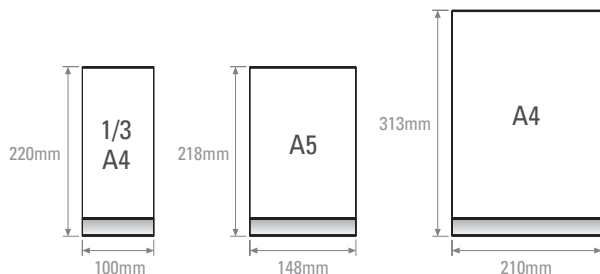

Simply grip the base open and insert the sleeve



Spring-powered 'grip-action' bases

You may also be interested in:



GripChalkers

Simple yet stylish table top chalkboards featuring our spring-powered 'grip-action' bases

See page 44

Specification					
Size	Base Dimensions (w x h x d mm)	O/A Height with Sleeve (mm)	Part	Weight (kg)	Order Code
1/3 A4 (DL)	100 x 18 x 84	220	Base only	0.5	SWBASE1/3A4
			PET sleeve	0.4	BHV100MH
A5	148 x 18 x 84	218	Base only	0.8	SWBASEA5
			PET sleeve	0.6	BHV150MH
A4	210 x 18 x 84	313	Base only	1	SWBASEA4
			PET sleeve	1.4	BHV210MH



Base/leg assembly using Allen key (supplied)

Decorative Menuboard

- Stylish internal poster display
- Front-opening **snapframes** for quick and easy poster change
- Round corners for safety (mitred corners available made to order)
- Anti-glare **PET poster cover** ensures clarity of message
- **Polystyrene base** with hidden **steel plate** for optimum stability
- Silver anodised **aluminium leg** (50 × 25mm oval)



In stock



5 minutes to assemble



Recyclable

Aluminium frame, polystyrene back panel, PET poster cover, aluminium leg, polystyrene (HIPS) base and steel base plate

Specification					
Size	Dimensions (mm)	Display Area (mm)	Weight (kg)	Format	Order Code
A4	O/A height: 1000 Frame: 240 × 327 Base: 250 × 330	279 × 192	3.5	Landscape	DMBA4L
				Portrait	DMBA4P
A3	O/A height: 1200 Frame: 327 × 450 Base: 300 × 420	402 × 279	6.7	Landscape	DMBA3L
				Portrait	DMBA3P



Classical Menuboard

- Traditional internal display for A3 landscape posters
- Front-opening **snapframes** for quick and easy poster change
- Choice of round or mitred snapframe corners
- Anti-glare **PET poster cover** ensures clarity of message



In stock

Mitred corner snapframes made to order



5 minutes to assemble



Recyclable

Aluminium frame, PET poster cover, polystyrene back panel, aluminium legs and steel base

Specification					
Snapframe Corners	Display Area (mm)	Dimensions (mm)	Weight (kg)	Stock Status	Order Code
Round	279 × 402	Base: 420 × 300 O/A height: 1200 Frame: 327 × 450	7.4	In stock	DLCMBA3LR
Mitred				Made to order	UCMBA12Y5A3

Portland Menustand



The clue is in the name... easy to convert between **portrait** and **landscape**, this highly versatile poster display is ideal for a huge range of applications, from showrooms, galleries, museums and exhibitions to hotels, restaurants, receptions and seminars

- Easily adjustable height – simple ‘clip and slide’ mechanism
- Quick and easy to change between portrait and landscape format
- Display angle easily adjustable between 0 and 90 degrees
- Front-opening **snapframes** for quick and easy poster change
- Soft round corners for safety
- All adjustments made by hand – no tools required
- Anti-glare **PET poster cover** ensures clarity of message
- Base features hidden **steel plate** for optimum stability
- Available in A4 and A3 stock sizes



In stock



3 minutes to assemble



Recyclable

Aluminium frame, PET poster cover, aluminium stand and steel base plate



In landscape mode

In portrait mode



Quick and easy to change between portrait and landscape format



Easily adjustable height – simply unclip and slide pole up/down



Bases feature hidden steel plate for optimum stability

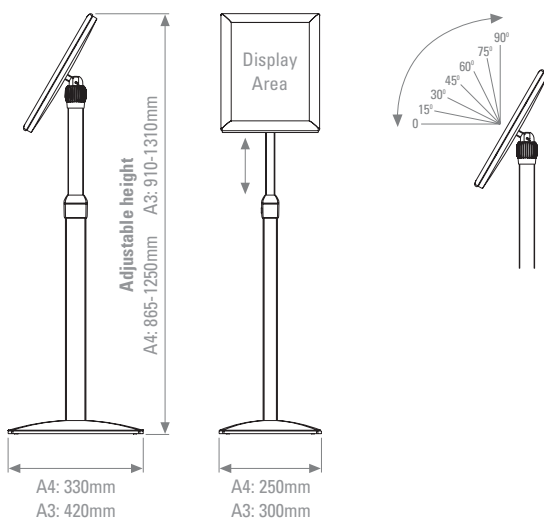

Specification					
Size	Format	O/A Dimensions (w × h × d mm)	Display Area (mm)	Weight (kg)	Order Code
A4	Landscape	330 × 865-1205 × 250	190 × 277	5.2	FLEXIMENUBORDA4
	Portrait	250 × 910-1250 × 330			
A3	Landscape	420 × 910-1250 × 300	277 × 400	6.8	FLEXIMENUBORDA3
	Portrait	300 × 970-1310 × 420			

Polemorphics®

Patent No. GB 2439165

Award-winning modular display system for:

- Posters
- Merchandise
- Banners
- Brochures
- Graphic panels
- And much more...



2-channel pole, Snapframe Header, A3 Poster Holders and A4 Brochure Holders

Display a wide range of standard components **simply by pushing** them into the pole.

Polemorphics' patented 'gripper channel' holds virtually any 2-3mm rigid sheet material securely in place, yet still allows you to **remove and rearrange** in seconds – no tools required!

Polemorphics is ideal for a **wide range of applications** – from retail, banks and car dealerships to travel and estate agents, museums, galleries and hotels... the 'polesibilities' are endless!



Simply push items into the pole – remove and rearrange in seconds



Unlimited display combinations can be achieved with just one pole – instantly updateable without tools

- Ideal for use in shop windows, with many advantages over suspended wire and rod systems **including price**
- Engineered to provide a long and **maintenance-free** life
- Does not require professional installation – avoiding associated cost and inconvenience

Standard Components for Polemorphics®

Pole, Boss & Base

Pole:

- Silver anodised **aluminium**, with 2 or 4 channels
- Maximum length of gripper channel: 1895mm

Base options:

- Boss only – die-cast **zinc alloy** with stainless steel label/screw cover plates, suitable for permanent floor mounting and use with custom bases
- 2-part **steel base** – silver powder coated finish, providing stability with convenience of easy repositioning

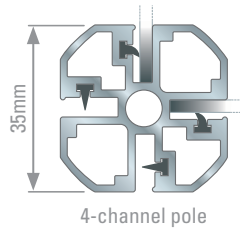
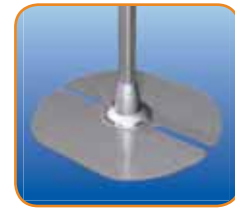
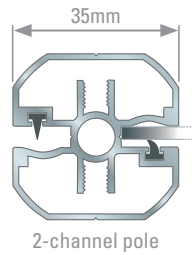

In stock



Recyclable

Aluminium pole, zinc alloy boss and steel base

Specification			
Item	Dimensions (w × h × d mm)	Weight (kg)	Order Code
2-channel pole & boss	Pole: 35 × 2000* × 35 Boss: 125 diameter	5.4	PMPA
4-channel pole & boss			PMPA4
2-part steel base	467 × 5 × 421	6.4	PMBP

*Height when used with standard base. With boss only, maximum height: 1995mm. Available in custom colours (minimum order quantity: 50).



Poster Holders



These **polycarbonate poster holders** provide an unbreakable poster display pocket with excellent UV resistance and a high health and safety rating. Unlike solid acrylic holders, these are flexible and spring back into position if they are walked into.

- Simply push into the pole – can be removed and repositioned in seconds
- Micro-magnet closure ensures pocket remains closed for a range of paper thicknesses
- Indestructible yet extremely flexible **polycarbonate**

Specification					
Poster Size	Format	O/A Dimensions (mm)	Weight (kg)	Stock Status	Order Code
A4	Portrait	238 × 313 × 2	0.2	In stock	PMA4PCP(SW)
A3	Landscape	448 × 313 × 2	0.3		PMA3PCPL(SW)
	Portrait	325 × 436 × 2			PMA3PCPP(SW)
A2	Portrait	448 × 610 × 2	–	Made to order	–



In stock

A2 made to order



Recyclable

Polycarbonate poster holders

Brochure Holders

- Simply push into the pole – can be removed and rearranged in seconds
- Clear 4mm PETG holders, giving great impact resistance and longevity
- Grey powder coated steel brackets
- Brackets available separately for custom holder designs
- Holder depth: 30mm. Maximum load: 2kg



Simply push bracket into the pole...



...and fit holder



In stock



Recyclable
PETG holders and steel brackets



Front Facing (right hand)

Single-Sided, Front Facing

Complete with steel bracket

Specification		
Size	Format	Order Code
1/3 A4 (DL)	Left hand	PMPETG1/3A4(LH)
	Right hand	PMPETG1/3A4(RH)
A5	Left hand	PMPETGA5(LH)
	Right hand	PMPETGA5RH)
A4	Left hand	PMPETGA4(LH)
	Right hand	PMPETGA4(RH)
Bracket only	Left hand	PMBRKTFRONTLH
	Right hand	PMBRKTFRONTRH



Side Facing

Single-Sided, Side Facing

Complete with steel bracket. Can also be used front facing with 4-channel pole.

Specification	
Size	Order Code
1/3 A4 (DL)	PMPETG1/3A4(SF)
A5	PMPETGA5(SF)
A4	PMPETGA4(SF)
Bracket only	PMBRKTSF



Double-Sided

Double-Sided, Front & Back Facing

Complete with steel bracket

Specification	
Size	Order Code
1/3 A4 (DL)	PMPETG1/3A4(DS)
A5	PMPETGA5(DS)
A4	PMPETGA4(DS)
Bracket only	PMBRKTDS

Snapframe Header

For A4 landscape posters

- Double-sided A4 landscape header (for posters up to 500 micron thick)
- **Snapframe sides** for quick and easy poster change
- **Steel aluminium casing** with silver anodised finish
- 2 x white **HIPS backing sheet** included, suitable for permanent graphics
- Extends height of standard pole to 2010mm (with standard base)



Slide header onto pole



Add top cap



Open snapframe sides and remove poster cover



Insert poster



Replace poster cover and close snapframe sides

Specification			
Poster Size	O/A Dimensions (w x h x d mm)	Weight (kg)	Order Code
A4 Landscape	310 x 214 x 72	1	PMHUD2

Available in custom colours (minimum order quantity: 50)



In stock



Recyclable

Aluminium snapframe sides, steel/aluminium casing, PET poster cover and HIPS backing sheet

Custom Header Bracket

Ideal for creating flat panel and 3D formed headers, the Custom Header Bracket simply unfolds and slots into place.

Flat panels can be made in metal, plastic or wood and simply cut to shape and printed or, by fabrication in layers of materials, they could produce built-up lettering or logos.

3D custom headers can be created through a variety of processes (e.g. vacuum forming), with endless possibilities for shape, finish and appearance.

- Clear **polycarbonate bracket**, supplied flat and simply folds into shape
- Self-adhesive pads allow instant attachment of header panels



Slide bracket onto pole...



...and apply header panels



2D flat panels



3D formed header

Specification		
O/A Dimensions (mm)	Weight (kg)	Order Code
90 x 60 x 40	0.2	PMCB



In stock



Recyclable

Polycarbonate bracket

Banner Arms

- Simply push bracket into the pole – can be removed and repositioned in seconds
- Suitable for a wide range of banner materials up to 1mm thick
- Available in 3 standard sizes for 300, 400 and 500mm wide banners
- Each kit includes a **steel bracket** and 2 silver anodised **aluminium poles** with internal grippers and grey swivel end caps



In stock



Recyclable
Steel bracket and aluminium poles



Rotate end cap and remove grippers



Push banner arm into pole



Push-fit grippers onto banner



Slide grippers back into poles

Specification		
Banner Width (mm)	Projection from Pole (mm)	Order Code
300	350	PMBANNERARM300
400	450	PMBANNERARM400
500	550	PMBANNERARM500



Shelf Bracket

- Simply push into place – can be removed and repositioned in seconds
- **Steel bracket** with silver powder coated finish
- Maximum display load: 3kg



In stock



Recyclable
Steel bracket

Specification	
Dimensions (mm)	Order Code
Height: 170 Width: 120 (dia. of mounting plate) Depth: 196	PMSHELFBRKT

Also available in custom colours (minimum order quantity: 100).

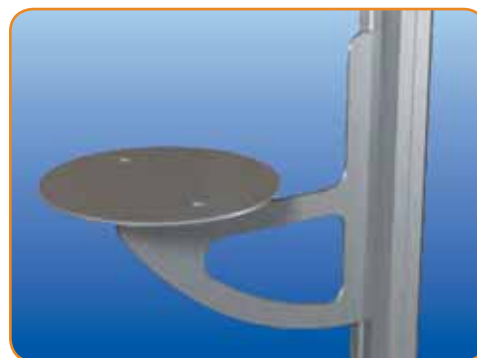

Insert bracket...



...and fix shelf (not included)

Suitable for shelves in a wide variety of designs and materials



HPL Chalkboard Panels

Using either 2 or 3mm 'High Pressure Laminate', Polemorphics can create a versatile chalkboard display – ideal for pubs, restaurants, cafes and bars.

Direct-to-surface screen and digital printing service available.



HPL See page 47 for more details

- Stays looking newer for longer
- Never needs re-painting
- Easy to clean
- Anti-glare surface ensures clarity
- Weather and scratch resistant



Custom Made Graphic Panels



Graphic panels provide endless opportunities for personalisation in either display board for short/medium term use or aluminium composite material (ACM) for long-term campaigns.*

- Simply push into the pole – can be removed and repositioned in seconds
- Maximum length of gripper channel: 1895mm
- Maximum recommended reach from pole: 500mm (based on 2mm thick material)



*Display board and aluminium composite materials are recommended for their resistance to heat distortion (particularly important for window displays that receive direct sunlight).

Budget Pole System

Low cost freestanding display for posters, brochures and banners

- Ideal for internal/temporary sheltered outdoor use
- Range of standard display options available



2-channel pole with Poster Frames (mitred corners) and steel Brochure Shelves



2-channel pole with Poster Frame (round corners) and acrylic Brochure Shelves



2-channel pole with Slide-In Frames and Banner Set



4-channel pole with Slide-In Frames and steel Brochure Shelf

Standard Components for Budget Pole System

Pole & Base

- 70 × 70mm silver anodised aluminium poles
- Silver powder coated steel bases



In stock



Recyclable
Aluminium poles and steel bases



2-channel pole
with circular base and domed end cap



4-channel pole
with square base and pyramid end cap



Specification				
Pole Type	Base Dimensions (mm)	O/A Height (mm)	Weight (kg) inc. base	Order Code
2-channel	450 (diameter) × 35	1920	12.4	BP2
4-channel	450 × 35 × 450			BP4

Poster Frames

- Front-opening aluminium snapframes for quick and easy poster change
- 30mm profile with choice of round or mitred corners
- Supplied with pre-fitted channel slider/clamps



In stock
A2 and A1 with round corners



Recyclable
Aluminium snapframes and PET poster covers



4-channel pole with A1 Poster Frame (round corners)

Specification				
Corners	Poster Size	Weight (kg)	Stock Status	Order Code
Round	A2	1.7	In stock	BPFRAMEA2
	A1	2.8		BPFRAMEA1
	500 × 700mm	2	Made to order	UFSL012000
	700 × 1000mm	3.5		UFSL014000
Mitred	A2	1.7	Made to order	UFSL005000
	A1	2.8		UFSL004000
	500 × 700mm	2		UFSL006000
	700 × 1000mm	3.5		UFSL008000



2-channel pole with 8 × steel Brochure Shelves

Brochure Shelves

- 2 × A4 portrait/1 × A3 landscape angled shelves
- Available in silver powder coated **steel** or **clear acrylic**



In stock
Steel Brochure Shelves



Recyclable
Steel/acrylic shelves



Steel

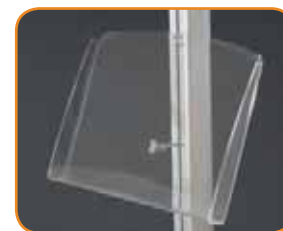

Acrylic

Specification				
Material	O/A Dimensions (w × h × d mm)	Weight (kg)	Stock Status	Order Code
Steel	460 × 310 × 40	1.8	In stock	BPSTEELSHELF
Acrylic		1.4	Made to order	UFSL003000



2-channel pole with 4 × A2 Slide-In Frames

Slide-In Frames

- Silver anodised **aluminium frames** with open top end
- Clear **PET poster cover sheets**
- Black **polystyrene inner sheet** included to provide light block between posters



In stock



Recyclable
Aluminium frame, PET poster cover sheets and polystyrene inner sheet



Specification			
Poster Size	O/A Dimensions (w × h mm)	Weight (kg)	Order Code
A4 Portrait	233 × 320	0.83	BPSLIFA4
A3 Portrait	320 × 443	1.2	BPSLIFA3
A2 Portrait	443 × 617	1.82	BPSLIFA2

Banner Set (Poster Hangers)

- Supporting arm simply slides into pole and screws in place
- Aluminium 'Poster Hanger' rails top and bottom, suitable for paper or banners up to 1mm thick (see page 33 for details)



In stock



Recyclable
Aluminium supporting arm and rails



2-channel pole with 2 x 600mm Banner Set

Specification			
Banner Height (mm)	Banner Width (mm)	Weight (kg)	Order Code
Up to 1700	400	0.28	BPBANARM400
	500	0.34	BPBANARM500
	600	0.41	BPBANARM600

Brochure Holders

- Made with crystal clear high impact polystyrene (HIPS)
- Options for direct pole mounting or side mounting



In stock
A4 and A5 with side mounting arm



Recyclable
High impact polystyrene (HIPS) brochure holders



Holders with side mounting arms

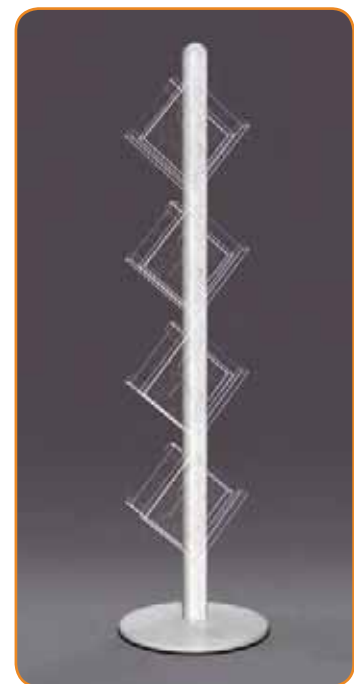

Angled pole mounted holders

Specification				
Type	Size	Weight (kg)	Stock Status	Order Code
With side mounting arm	A4	0.85	In stock	BPSIDESHelfA4
	A5	0.55		BPSIDESHelfA5
	1/3 A4	0.35	Made to order	UFSLI40200
Angled for pole mounting	A4	0.45	Made to order	BPANGBHA4





All Printed Displays are **made to order**



Optional brushed stainless steel stand-off fittings

Dealer/Stockist Signs

Minimum order quantity (guide): 25

- Available in almost any size and shape
- Vibrant screen printing provides 5+ years outdoor life
- Digital print also available, with optional matt or gloss screen varnish to extend outdoor life
- Available in aluminium, foam PVC, acrylic, PET or polycarbonate to suit application and budget
- Pre-drilled ready for screw or nail fixing



Banners

No minimum order quantity

- Available in a choice of materials (see below) up to 5m (w) x 24m (l)
- 6-12 months outdoor life
- Folded hems provide a 'double-strength' perimeter for optimal wind-load resilience
- Eyelets fitted as standard (silver finish metal or clear polycarbonate, depending on quantity)
- All banners supplied with nylon tie-wraps (1 per eyelet) – quick and easy to use, achieve best appearance and extremely secure
- All banners individually poly-bagged, providing protection throughout storage and distribution



Silver finish metal eyelet



All banners supplied complete with tie-wraps



Light Block PVC

Premium quality and perfect for double-sided print

- 0.5mm/750gsm with high tenacity polyester fibre reinforcement
- High strength and totally opaque
- Long outdoor life and vibrant colour reproduction



Front-Lit PVC

Cost-effective yet high quality, for single-sided print

- 0.3-0.4mm/400gsm with high tenacity polyester fibre reinforcement
- For single-sided print with white or single colour on reverse
- 'Brilliant white' surface guarantees optimal colour vibrancy
- 69% PVC/31% polyester make-up ensures excellent outdoor performance



Polyethylene

Great value and 100% recyclable, for single-sided print

- 0.24mm/190gsm woven polyethylene, suitable for PE4 recycling channels
- Extremely high strength/rip resistance
- Heat-welded hems and clear recyclable polycarbonate eyelets as standard
- For single-sided print with white on reverse

Open/Closed Signs

Minimum order quantity (guide): 25

Premium

An extremely effective, functional and innovative piece of POP designed in-house and proving to be a hit for everyone who sees it!

- Displays up to 4 messages in one
- Opening time sheets included – simply peel off and stick in the appropriate day/time slot
- Double-sided insert – rotate/reverse to display opening times or alternative message



Simply pull tabs on reverse to change open/closed message



1. Insert panel simply slides out



2. Rotate to show alternative message

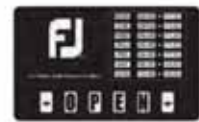

3. Slide insert back into position



Inserts can be printed on reverse to provide up to 4 different messages



Round

Simple 'pull-tab' function

200mm diameter

Slider

2-piece PVC sign. Simply slide sleeve along to change open/closed message.



Postcard Holder

Minimum order quantity (guide): 50

- Prime position brand presence with real value to the retailer and the consumer
- Made in polypropylene and die-cut to shape with vibrant screen printed graphics
- O/A dimensions: 510 x 760mm

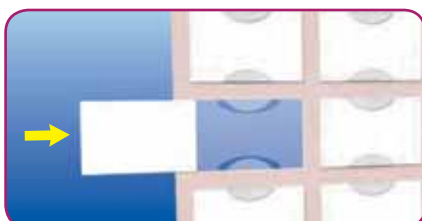

Postcards are held in place by die-cut tab holders – quick and easy to insert/remove



Solar Pendulum

The Premium Wobbler – ideal for counters, shelves, tills, back bars and window displays

- Self-starting motor
- Interchangeable graphics – Velcro pads for quick and easy updating
- Freestanding or fixing solutions to suit
- 2 or 3 piece graphics – made with washable 220/440 micron PVC

Powered by sunlight or ambient store lighting – no batteries required!



Creative placement – a great way to bring attention to behind-the-bar promotions



Graphics supplied complete with pre-applied Velcro pads for ease of assembly



Freestanding 3-piece design



Shelf-front unit driving impulse sales



Freestanding 2-piece design

Specification		
Panel	Dimensions (mm)	Material
Back (optional)	112 x 180	440 micron PVC
Moving	65 x 110	220 micron PVC
Front	65 x 93	220 micron PVC

Mobiles

Minimum order quantity (guide): 50

- High impact 3 and 4 sided hanging displays
- Graphic panels simply clip on and off – quick and easy to change
- Lightweight, flat-packed and easy to assemble
- Use individually or link together (hooks included)



Use individually or link together



Adjustable hook included with each unit



3-sided top and bottom mouldings for 400mm or 500mm wide panels



4-sided top and bottom mouldings for 400mm wide panels

Brand Blocks

Minimum order quantity (guide): 50

Also known as 'logo blocks', these simple, stylish and highly effective brand promoters are ideal for windows, counter tops and shelves.

Cut to size in high quality 20mm crystal clear acrylic, Brand Blocks are reverse-printed to achieve that characteristic visual depth and diamond-edge polished as standard for optimum clarity from every angle.

Frequently used in jewellery and watch display cabinets, clothing outlets, electrical retailers and financial services to name a few!

Available in 3 standard sizes and custom sizes made to order.

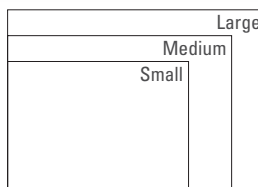

Large:
150 × 105mm

Medium:
130 × 90mm

Small:
105 × 75mm

Cheque/Counter Mat

Minimum order quantity (guide): 50

- Functional item with real value to the retailer
- Special soft lay-flat writing surface – comfortable to use
- Choice of size and shape with vibrant screen printed graphics
- Easy to clean



Basket Liners

Minimum order quantity (guide): 250

- Increase impulse sales amongst basket shoppers
- Scuff resistant printed promotional inserts
- Quick, easy and cost-effective
- Available in 'square cut' or custom shapes (one-off cutter charge applies)



Napkin/Beer Mat Holders

Minimum order quantity (guide): 50

Made in high impact polystyrene (HIPS) with screen/digitally printed graphics, these eye-catching holders deliver brand presence with functional purpose.

Available in a wide variety of shapes and sizes.



Multi-Cup Display

Minimum order quantity (guide): 50

Precisely cut spaces hold cups securely in place and vibrant screen/digitally printed graphics ensure the Multi-Cup Display is not only informative and helpful but visually appealing as well.

Made in high impact polystyrene, this is cost-effective to produce in small quantities, lightweight and easy to clean with a high quality gloss finish.





All Product Display & Presentation products are **made to order**



Steel Beartrap with gloss black finish and vinyl sticker

Beartrap Tyre Stand

Minimum order quantity (guide): 50

This simple yet stylish display stand is available in steel, aluminium or high impact polystyrene (HIPS) and almost any colour, with either vinyl branding (steel/aluminium) or direct-to-surface printed graphics (HIPS).

The Beartrap's 2 sections simply slot together and are easily adjustable to suit different tyre sizes.

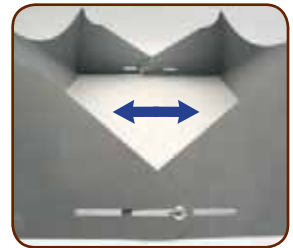
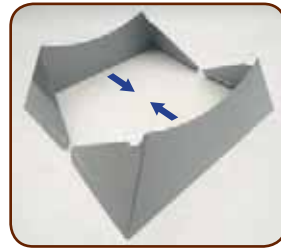

Built-in sliders make it easy to adjust for different tyre sizes



Tyre Trolley

Minimum order quantity (guide): 50

The Tyre Trolley has been a successful industry 'generic' product for many years. It provides that perfect combination of effective product promotion and functional purpose that makes it a winner with brands and retailers alike.

Consisting of a steel frame with customised aluminium header, the Tyre Trolley flat packs for efficient distribution, has a simple 'no tools' assembly method and features a central security bar and padlock.



Ice Cream Holders

Minimum order quantity (guide): 25

- Made in 2mm powder coated aluminium
- Choice of sizes to choose from
- Low minimum order quantities
- Optional non-slip feet



Freestanding Tiered Dumpbin

Minimum order quantity (guide): 100

- Hard wearing crystal polypropylene with powder coated steel base
- Quick and easy 'no tools' assembly
- High visibility, low cost product display
- Height: 1555/1212mm (with/without header); Diameter: 300/400mm (tube/base)



Clever flat-pack design for efficient storage and distribution



Counter Top Dumpbin

Minimum order quantity (guide): 200

- Durable, hard wearing and washable
- Cost-effective impulse sales driver
- Screen printed, die-cut crystal polypropylene
- Dimensions: 250mm (diameter) x 250mm (height)



2 part flat pack design



Gravity Can/Tube Dispenser

Minimum order quantity (guide): 250

- Injection moulded clear ABS/styrene
- Modular design – can be used individually or linked together
- Available for non-standard pack sizes, subject to minimum quantity and one-off design/tooling charge



Case Stacker

Minimum order quantity (guide): 50

Ideal for large items such as food and drink multi-packs, the freestanding Case Stacker is easily adaptable to suit different product sizes and shapes, with optional shelves for lightweight items.

The powder coated steel frame can display header and side graphic panels in a variety of materials such as card, plastic and aluminium, all of which flat packs for efficient storage and distribution.



Tiered Product Display Racks

Good design and simple 'no tools' assembly guarantees maximum store compliance from our attractive racking systems

Metal Racks

Minimum order quantity (guide): 200



Recyclable
Steel and polycarbonate

Our wire racks combine the cost benefits of a standard plastic moulded rack with the flexibility of a bespoke design. Shelf size, number of tiers and heights, colour and branding treatments can all be customised without a tooling charge in sight! Combine this with flat-pack distribution and these high compliance rated, secondary placement FSDUs will be a hit for brands and retailers alike.

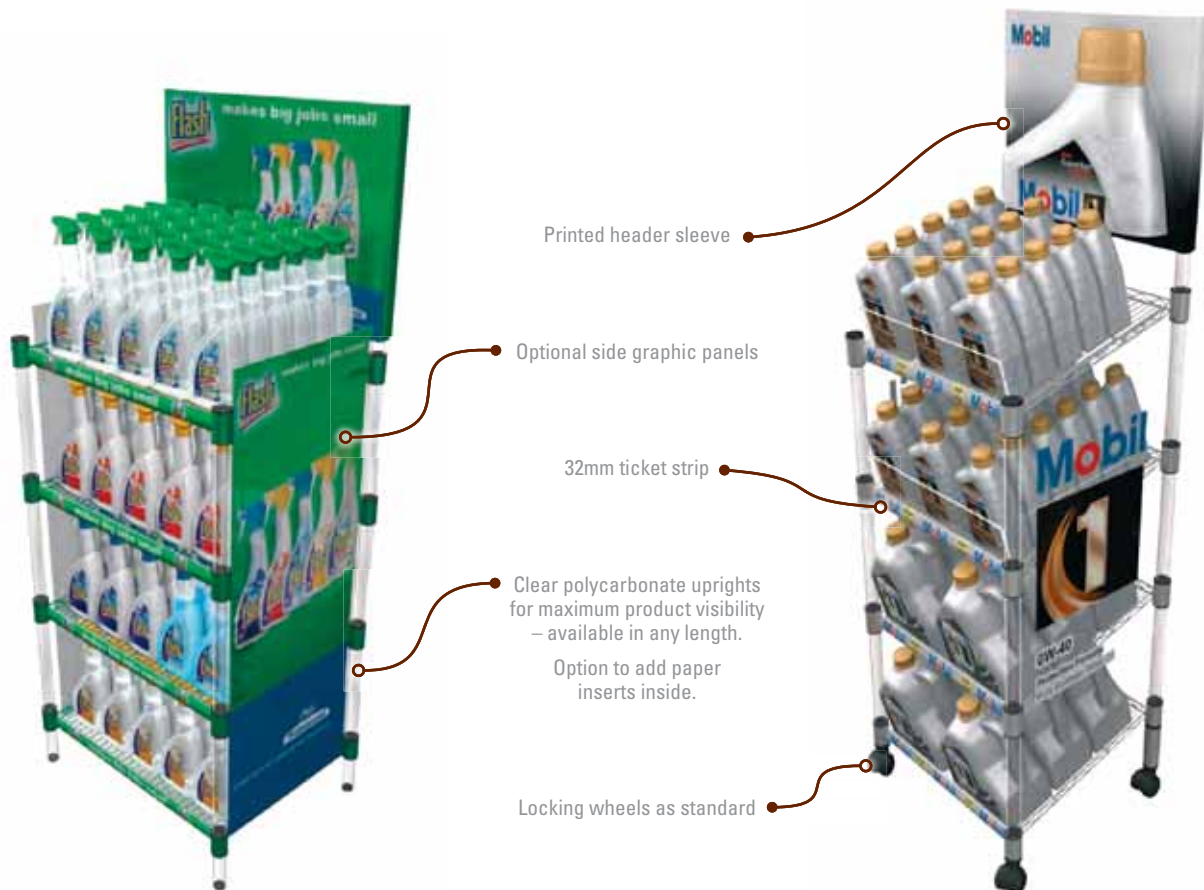

Mastershelf

Gravityshelf



Custom base for a shallow rack design and alternative look



Racks can be made to any size and finished in virtually any colour



Made to measure wire shelf dividers for Gravityshelf – simply clip into position

Both metal and plastic rack systems lend themselves to an array of creative graphic treatments to bring your display to life...

Wings, wobblers, solar motors and illumination can be used to enhance traditional headers and side panels.

Plastic Racks

- Choice of 2 standard leg heights and optional raised feet (see table below)
- Proven to be cheaper than cardboard displays and much longer lasting
- Minimum economical run: 1000 trays



Recyclable
Polypropylene trays and styrene legs



Optional raised feet



Rear view showing updateable header mounting detail



Promo card holder moulded into each tray

Trays include moulded recesses for brand labels

Specification	
Item	Dimensions (mm)
Leg 1	325 (space between racks)
Leg 2	385 (space between racks)
Feet	85 (from ground to underside of first rack)

The combination of injection moulded polypropylene trays and unique tapered styrene legs results in a plastic rack system that is **stronger** and **more rigid** than typical plastic rack designs as well as being **fully recyclable**. Not only **hard wearing**, **easy to clean**, **updateable** and **fully modular** from one up to five tiers, **cost savings of over 50%** have been demonstrated versus cardboard displays. Plastic racks also allow access from all sides if required – something you won't get from a cardboard unit.

Adfresco® Café Barrier

Patent No. GB 2472843

The ultimate in quality and design



- Unique **patented design**
- **Highest quality** 3-series **stainless steel** throughout – excellent outdoor performance and high chip/scratch resistance
- **Quick and easy** to assemble – simple pictorial instructions and Allen keys provided
- **Fully compliant** with Local Authority and Disability Discrimination Act (DDA) requirements
- Range of banner size and **material options available** (see following page)
- **Flat packed** with sectional **cross rails** for ease of distribution and storage



Use individually or link together



In stock
All printed banners are made to order



Recyclable
Stainless steel cross rails, poles and bases.
Designed for easy 'end of life' recycling.



Cross rails with easy 'clip-in' attachment – intuitive quick-release operation



Rigid lower cross rails ensure audible 'tap' and resistance for the visually impaired (fully DDA compliant)



14.4kg stanchions with 360mm diameter bases for optimum stability.
Durable rubber base edges prevent damage to base/floor and give option to 'roll' rather than lift.



Unique 'smooth glide' sliding ring:

- Improves stability by allowing banner to flex in the wind
- Aids banner/cross rail installation and removal
- Keeps banner flat
- Eliminates rattling and pole damage associated with metal variants

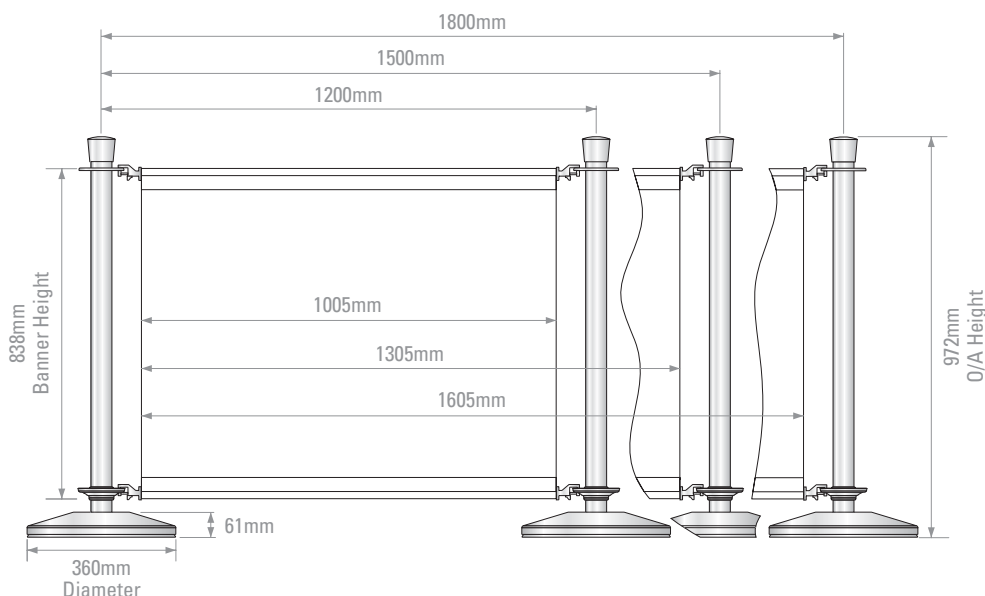

Chrome plated 'Eye Plate' available for wall mounting

Specification			
Item	Dimensions (mm)	Weight (kg)	Order Code
Pole	O/A height: 972 Diameter: 51	0.9	CBBPOLER
Sliding ring	110 (dia.) x 30 (h)	0.3	CBBRING
Base	Height: 61 Diameter: 360	13.5	CBBBASE
Cross Rail (2 per banner required)	Length: 1200*	0.8	CBCR1200
	Length: 1500*	1.3	CBCR1500
	Length: 1800*	1.4	CBCR1800
Banner	1005 x 838	-	Please call for details
	1305 x 838		
	1605 x 838		
Eye Plate (for wall mounting)	40 x 40 x 35 (w x h x d)	0.06	CBBEYERING

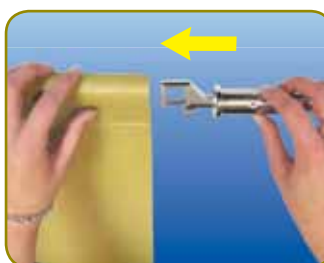

Quick and easy to use – simply slide cross rail into banner hem and roll-up for storage



*Refers to distance between centres of poles.

Printed banners available in a choice of materials:

Light Block PVC

Reinforced and totally opaque, this is perfect for double-sided print, long outdoor life and vibrant colour reproduction. The easy 'wipe clean' surface makes it ideal for front-of-house food and drink environments.

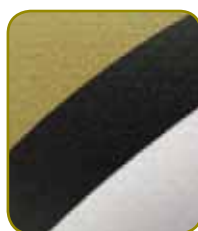

Front-Lit PVC

This material has a woven textured surface and canvas appearance, providing a high quality print surface on one side with white or single colour on the reverse. Unlike cotton-based canvasses, it is cost-effective, will never stain, fray or rot, and delivers vivid colour reproduction across the full spectrum.

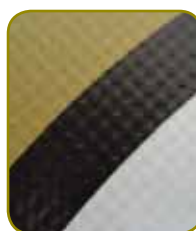

Mesh PVC

Provides a semi-transparent finish and allows some air to pass through, making it ideal for windy locations, 'subtle branding' and creating a 'style-bar' look. Full colour print is available on one side with white or single colour on the reverse.



Polyester Canvas

A traditional woven canvas fabric with a dense construction and natural white colour for excellent colour reproduction. This 100% polyester material offers full colour print on one side, with white or single colour on the reverse.

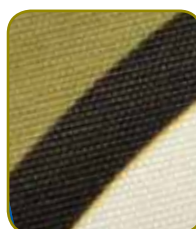

All our banners are suitable for outdoor use

Pole & Rope Barrier

Featuring our high quality Adfresco® poles and bases combined with a choice of rope styles and colours



Velvet Rope (above) and Twisted Rope (below)
Available in 3 stock colours



- **Highest quality** 3-series stainless steel throughout with high chip/scratch resistance
- **Quick and easy** to assemble – simple pictorial instructions and Allen keys provided
- Ropes feature easy 'clip-in' attachment – intuitive quick-release operation
- 14.4kg stanchions with 360mm diameter bases for optimum stability
- Durable rubber base edges prevent damage to base/floor and give option to 'roll' rather than lift
- Flat packed for ease of distribution and storage

Polished brass and polished black finishes also available

Minimum Order Quantities
Poles/Bases: 100
Ropes: 100
(Extended lead times apply)



In stock



Recyclable
Stainless steel poles and bases.
Designed for easy 'end of life' recycling.



14.4kg stanchions with 360mm diameter bases for optimum stability



Ropes feature quick and easy 'clip-in' attachment



Chrome plated 'Eye Plate' available for wall mounting

Specification				
Item	Colour/Finish	Dimensions (mm)	Weight (kg)	Order Code
Pole	Polished stainless steel	O/A height: 972 Diameter: 51	14.4 (pole: 0.9; base: 13.5)	CBBPOLER
Base		Height: 61 Diameter: 360		CBBBASE
Velvet Rope (with foam core and chrome end clips)	Red	Length: 1500 Diameter: 35	0.6	CBBVROPERED
	Black			CBBVROPEBLACK
	Blue			CBBVROPEBLUE
Twisted Rope (cotton/polyester with weighted core and chrome end clips)	Red	Length: 1500 Diameter: 30	0.6	CBBTROPERED
	Black			CBBTROPEBLACK
	Blue			CBBTROPEBLUE
Eye Plate (for wall mounting)	Chrome	40 × 40 × 35 (w × h × d)	0.06	CBBEYERING

These ropes are designed for a long, maintenance free life indoors. Outdoor use in sunlight or rain will cause the rope colour to fade and reduce the life of the product.

Accessories & Spares



In stock
Unless otherwise stated

Image	Product	Colour	Size (mm)	Order Code
	Poster Cover Sheets (anti-glare PET) for A-Master, Snapframes, Sightmaster 2, Cyclone and Defender	Clear	A2	PET420594
			A1	PET594841
			A0	PET8411189
			20" × 30"	PET524778
			30" × 40"	PET1035781
			40" × 60"	PET15461036
	Swinger Aluminium Panels for vinyl or screen/digitally printed graphics	White	430 × 625 (Eco Swinger)	ECOPANWPAC
			430 × 750 (Eco Swinger 2)	EXECOPANWPAC
			500 × 750 (Swinger 2000)	SWI2PWPAC
			588 × 917 (Swinger 3000)	SWI3PWPAC
	Swinger Poster Pockets (top-opening) with printed border and magnetic closure (polycarbonate)	White border	500 × 750 (A2, Swinger 2000)	SW2000WPANTOPPAC
		Black border		SW2000BPANTOPPAC
		White border	588 × 917 (20" × 30", Swinger 3000)	SW3000WPANTOPPAC
		Black border		SW3000BPANTOPPAC
		Black border	674 × 997 (A1, Swinger 4000)	SW4000BPANTOPPAC
	D-Flex Panel Hanger for Eco Swinger and Eco Swinger 2 (pack of 2)	Black	21 × 60 × 42	ECOSWIDFLEXREPKIT
	D-Flex Panel Hanger for Swinger 2000, 3000 and 4000 (pack of 2)	Black	15 × 44 × 54	SWIDFLEX2REPKIT
	Wall Bracket for Swinger 2000 panels (while stocks last)	Black	510 × 100 (approx.)	SWPETWB
	Magnetic Poster Cover Sheets (anti-glare PET with border) for Informer and Booster	White border	A2	INFA2CWPAC
		Black border		INFA2CBPAC
		White border	20" × 30"	INF2030CWPAC
		Black border		INF2030CBLKPAC
		Silver/grey border		INF2030CSPAC
		White border	A1	INFA1CWPAC
		Black border		INFA1CBLKPAC
	Self-Adhesive Magnetic Tape (A)	Brown	12mm × 30m	TAP0006
	Self-Adhesive Magnetic Tape (B)			TAP0043
	Self-Adhesive Steel Tape	White	12mm × 30m	TAP0007
	Tactical Header Clip for Swinger 2000, 3000, 4000 and Sentinel	Black	25 × 52 × 60	SWINGERCLIP01
	Ecoflex Panel (Aluminium) for vinyl or screen/digitally printed graphics	White	460 × 850	ECOFLEXPANH28PAC
	Ecoflex HPL Panel for chalk, vinyl or screen/digitally printed graphics. Can only be used in Ecoflex HPL bases.	Black	460 × 850 × 3	HPLCOFLEXPAN
	Chalk Insert Panels for A-Master, Informer, Booster and Sightmaster 2	Black	20" × 30"	INF2030CCB
			A1	INFA1CCB
			A2	INFA2CCB
	Opening Tool for Security Snapframes	Grey	Length: 113	SFS0T01
	HPL Chalkboard Panels for Premier Chalk A-Boards	Black	Small: 563 × 813 × 3	HPLPREMBOARDISM
			Large: 730 × 1049 × 4	HPLPREMBOARDLIG

Accessories & Spares



In stock
Unless otherwise stated

Image	Product	Colour	Size (mm)	Order Code
	Acrylic Brochure Shelves for Info Board	Clear	440 × 40 (single-sided, 2 × A4)	INFOSHLFSG
			440 × 40 (double-sided, 4 × A4)	INFOSHLFDS
	Magnetic Pins for Slimlok 3 Noticeboard, Menu Case and Illuminated Menu Case (set of 8)	White	16 (h) × 12 (diameter)	MAGPINSETS
	Extension Cable for Slimlok 3 Illuminated Menu Case and Edgelit XT	Black	3m	3000MM
	Chalk Pens (see page 47 for full details)	Assorted	5 × 5mm nib (small)	CHALKPENSET1
		White	3 × 15mm nib (large)	CHALKPENSET2
	Poster Cover Sheets for Sentinel (polycarbonate)	Silver border	30" × 40"	SEN34MK4PANEL
			A0	SENA0MK4PANEL
			40" × 60"	SEN46MK4PANEL
	Trolley	Silver	225 × 1220 × 225	TROLLEY
	Adaptor (req. for Sightmaster 2)	Silver	90 × 45 × 48	TROLLEYADAPTOR
	Hose	Yellow	5000 × 13	SENHOSE
	Concrete Bases for Defender	Grey	600 diameter for 30" × 40" (56kg)	KIT01
			800 diameter for 40" × 60" (97kg)	KIT02
	Hard Trolley Case/Counter for Curved Pop-Ups	Black	593 × 890 × 400	MPUC
	Counter top	Black	700 × 8 × 500	MPUCTT
	Graphic fitting strips only	Black	–	GWSTRIPS
	Carry Cases for Quick Banners (BCB10 also for X-Banner Stand)	Black	Banner width: up to 800	BCB8
			Banner width: up to 1000	BCB10
	Carry Cases for Double-Sided Smart Roll Banners (made to order)	Black	Banner width: 800	UYUP070000
			Banner width: up to 1000	UYUP071000
	Carry Bags for Promo Counters	Black	Convex (in stock)	CONVXBG
			Hexagonal (made to order)	UYUP074100
	Cross Base for Flying Banners	Grey	840 × 60	FBBASE(2)
	Water Bag for Flying Banners (use with Cross Base)	Grey	540 diameter	FBBAG(H)
	Ground Spike for Flying Banners	Silver	500	FBSPIKE(2)
	Wheel Base for Flying Banners	Black	480 × 35 × 520	FBWHEEL(2)

Recommended Poster Materials

To ensure best performance against condensation/moisture ingress in outdoor poster advertising, we recommend:

For 1-3 months life

Wet strength, water resistant or waterproof paper (115–200gsm)

Additives included during paper manufacture prevent the paper from breaking apart when in contact with moisture, ensuring it remains strong and stable. These are common specification for short to medium term poster campaigns and billboard advertising.

For 3 months+ life

Lamination – 'encapsulating a paper poster in thin sheets of clear plastic'. This is also the only means of creating posters for outdoor use when 'water-based' inks are used. Delivers reliable performance if the encapsulation is made to seal around the whole perimeter of the poster.

Printing onto plastic – Synthetic Paper (80 micron minimum thickness polypropylene), sometimes termed 'Poly Poster', or 220 micron PVC are cost effective alternatives for longer-life applications e.g. displaying a business service offer, restaurant menus or repeating seasonal promotions.

Paper Sizes

Size	Millimetres	Inches
A0	841 × 1189	331/8 × 463/4
A1	594 × 841	233/8 × 331/8
A2	420 × 594	161/2 × 233/8
A3	297 × 420	113/4 × 161/2
A4	210 × 297	81/4 × 113/4
A5	148 × 210	57/8 × 81/4
A6	105 × 148	41/8 × 57/8
A7	74 × 105	27/8 × 41/8
1/3 A4	99 × 210	8 × 41/4
20" × 30"	508 × 762	20 × 30
30" × 40"	762 × 1016	30 × 40
40" × 60"	1016 × 1524	40 × 60

Conversion Table

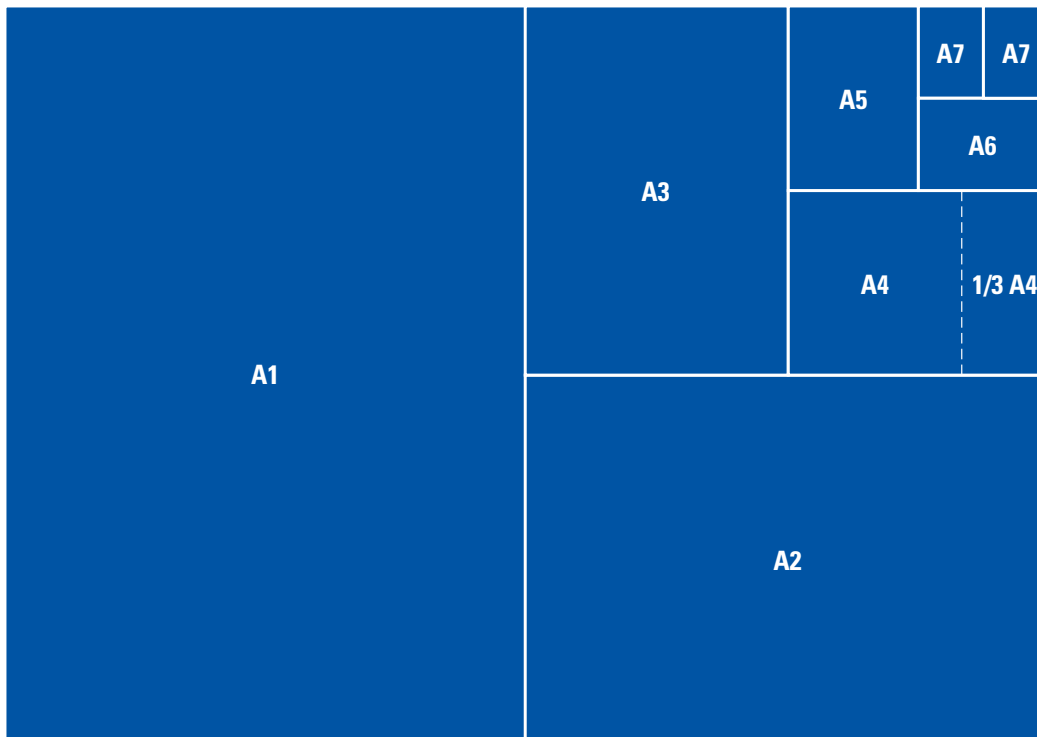

Description of Goods

Before using any of these products, the customer shall determine the suitability of the product for its intended use, and the customer assumes all risks and liability whatsoever in connection herewith. The supplier shall not be liable either in tort or in contract for any loss or damage – direct, incidental or consequential, arising out of the use of, or the inability to use any of the products.

All specifications, drawings, illustrations, particulars of weight and dimensions issued are approximate only and do not form part of any terms, conditions or warranties of any contract. The supplier may vary such specifications, drawings, illustrations, particulars of weight and dimensions at any time and for whatever reason, without having to give a reason or explanation.

T: 01924 46 70 31

F: 01924 66 71 88

E: hello@space3.co.uk

space3.co.uk

Space3 Creative Ltd
Carlisle House, Bretton Street,
Dewsbury, W Yorkshire, WF12 9BJ

